



## PRODUCT GUIDE

TIMBERS | LUMBER | SIDING | MOULDING | DOORS | TRIM | AND MORE



Image provided by WRCLA



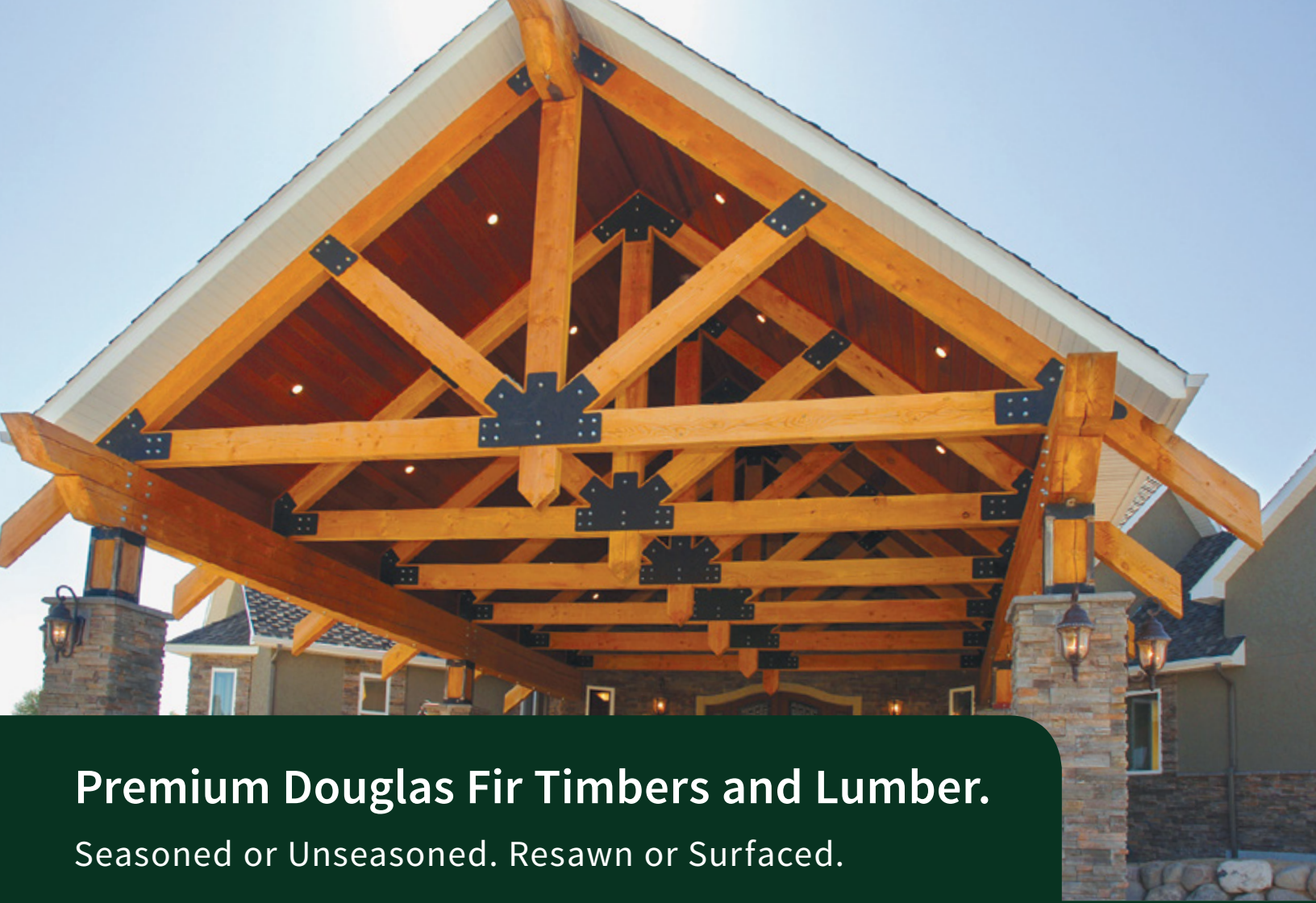

## Premium Douglas Fir Timbers and Lumber.

Seasoned or Unseasoned. Resawn or Surfaced.



**Quality, Integrity, Commitment to Service**

Since 2001

See our products on page 42

# TABLE OF CONTENTS

## FOREWARD 2-3

About OrePac.....	2
Trusted Brands .....	3

## ASPEN 4-5

Paneling .....	4-5
----------------	-----

## CEDAR 6-35

Siding Profiles.....	6-22
Dimensional and Post Timbers.....	23
Prairie Wood.....	24-25
Port Orford Decking .....	26-28
Split Rail Fence.....	29
Fencing.....	30
Shake and Shingle.....	31-35

## DOORS 36-41

Exterior .....	36-37
Interior .....	38-39
Barn and Bifold .....	40-41

## DOUGLAS FIR 42-56

Beams and Post Bases.....	42-47
Flooring.....	48-49
Siding.....	50-56

## ROOF PROTECTION 57-59

Felt.....	57
Synthetic.....	58-59

## MOULDING & MILLWORK 60-79

Overview .....	60-61
Architrave and Base.....	62-65
Casing.....	66-70
Crown.....	71-72
Miscellaneous Detail.....	73-79

## FINISHES 80-82

Messmer's Finishes .....	80-82
--------------------------	-------

## PINE (PPLP) 83-88

Boards and Patterns.....	83-85
Installation and Finishing.....	86-88

## SIDING 89-94

Siding Installation .....	89-94
---------------------------	-------

## MAHOGANY & TROPICALS 95

Decking/IPE.....	95
------------------	----

## COMPOSITE SIDING 96-101

Woodtone™ RusticSeries™ .....	96-98
Installation and Finishing.....	99-101

## WEATHERIZATION SYSTEMS 102-103

DuPont™ Tyvek® DrainWrap™ ....	102-103
--------------------------------	---------

## APPENDIX 104-110

# ABOUT OREPAC



OrePac is a wholesale building materials supplier providing product, sales, and technology solutions to the shelter industry.

## Our History

OrePac is a family-owned and operated business, founded by the Hart family in 1976. Through strong leadership and a commitment to success, the company has grown into one of the premier distributors in the building industry.

Trust, integrity and a dedication to excellence are the values most important to OrePac. That commitment can be found in the services we offer, the quality of the products we provide, and the way we treat our employees and customers. This dedication to our markets has enabled us to make a positive impact on the shelter industry and the communities we serve.

FOREWORD

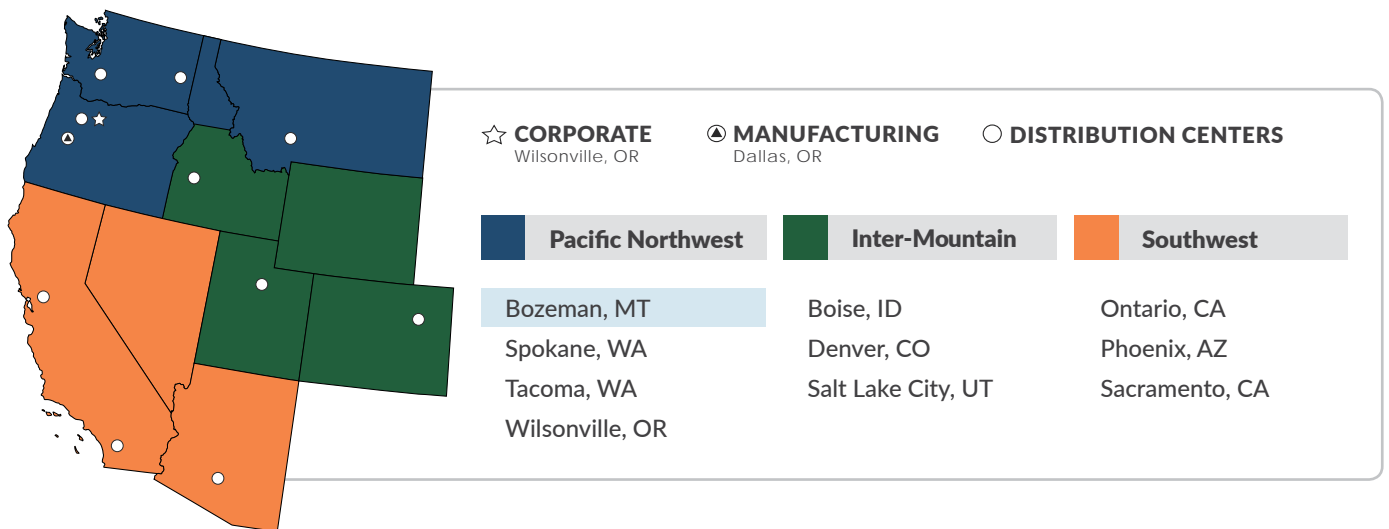



# TRUSTED BRANDS





## ASPEN WALL WOOD™



Aspen wood is the premier choice for wood paneling your walls, ceilings, furniture or unique projects. Aspen Wall Wood™ is the established leader in harvesting, milling, and producing sustainable Aspen wood paneling. Our top of the line products are unparalleled in quality, look, and durability. Whether you are looking for new home construction, home renovation or smaller DIY home projects, consider Aspen wood for a truly unique and one-of-a kind installation.



# ASPEN WALL WOOD™ PANELING



Spearfish, SD



Sheridan, WY



Aspen Wall Wood™ products are a cut above the rest. Aspen Wall Wood™ paneling is used for ceilings, walls, cabinets, and even floors. The light nature of Aspen brings the desirable warmth of wood into your home without the dark coloring of some species. Wall Wood™ products are low maintenance, requiring only a clear sealer once in a lifetime. Aspen is light too: weighing only about one pound per board foot, making it easy to handle and install.

Aspen Wall Wood™ carefully harvests Aspen trees, then creates a number of products leaving zero waste. The entire tree is utilized including sawdust for animal bedding, slabs for firewood, and our unique aspen paneling product lines.

## 1" x 6" T&G Wall Paneling

6', 8', 10', 12' Lengths

270 Pc/Unit

*Custom prefinishing available.*



Big Sky, MT

	Calculate Coverage		
	Area to Be Covered	Conversion Factor	Board Feet Needed
1" x 6" T&G		X 1.20 =	
1" x 8" T&G		X 1.19 =	
1" x 8" Channel		X 1.21 =	
1" x 10" Channel		X 1.16 =	
11/16" x 6 Bevel		X 1.34 =	
11/16" x 8 Bevel		X 1.24 =	
3/4" x 8 Bevel		X 1.13 =	
1-1/4" x 8 Bevel		X 1.25 =	

\*To calculate area: length (in inches) multiplied by width (in inches), divided by 144 inches.



Channel



Bevel / Dolly Varden

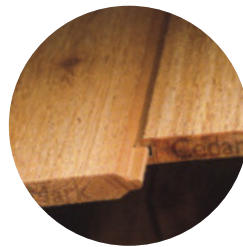

T&amp;G



# STK INLAND RED CEDAR 7/8" & 11/16"

## STK KD

1" x 4"      1" x 8"      1" x 12"  
 1" x 6"      1" x 10"

## T&G WP4 Reversible

1" x 6", 11/16", Net  
 1" x 8", 11/16", Net

## STK KD Rustic Channel

1" x 8"      1" x 10"



**T&G Rough Side**

1" x 6" and 1" x 8"



**T&G Smooth Side**

1" x 6" and 1" x 8"



**Channel Rustic**

1" x 8" and 1" x 10"

*Custom prefinishing and Messmer U.V. Plus Protection available.*

## Plain Butt | Resawn Face

11/16" x 6"  
 11/16" x 8"

## Rabbeted Butt | Resawn Face

1" x 6", 11/16", Net  
 1" x 8", 11/16", Net

## Primed Beveled Siding

Cedar bevel siding and paneling are two of the most popular siding choices. Both are available with a smooth or resawn face to precisely match your trim and fascia. Evergreen comes in convenient and easy to handle long lengths to increase the speed and ease of installation.



**Rabbeted Butt Siding**

3/4" x 8" and 1-1/4" x 8"





*Custom prefinishing and Messmer U.V. Plus Protection available.*

## Bevel Siding | Clear KD Trim & Fascia | Finger Joined/Edge Glued

1/2" x 4"	Clear Vertical Grain Heart or Aye/Smooth or Resawn Face	8', 12', 16', and 20' lengths
1/2" x 6"	Clear Vertical Grain Heart or Aye/Smooth or Resawn Face	8', 12', 16', and 20' lengths

# CEDAR CHANNEL



-  Horizontal Install
-  Vertical Install
-  Ceiling Install
-  Stained Install



# HAIDA SKIRL CEDAR\*



CEDAR



Haida Skirl Cedar  
Unstained



Haida Skirl Cedar  
Stained

### Product Sizes Available

- 15/16" x 10"
  - 15/16" x 12"
- Custom prefinishing available.*

\*Haida Skirl Cedar products require additional lead time.

# 1/2" x 8" CVG WR CEDAR



Rapids City, SD



## Product Sizes Available

1/2" x 8"

*Custom prefinishing available.*

**CVG WR Cedar**

Shown with custom stain



# 11/16" x 8" BEVEL LAP SIDING



Sheridan, WY



Spearfish, SD



**Bevel Lap Siding**

Shown with custom stain



**Bevel Lap Siding**

Shown with Messmer's  
U.V. Plus Charcoal stain

## Product Sizes Available

11/16" x 8"

*Custom prefinishing available.*

# RABBETED BUTT SIDING

CEDAR



Bozeman, MT



Sheridan, WY



Rabbeted Butt Siding  
Messmer's Stain



Rabbeted Butt Siding  
Custom stained

## Product Sizes Available

3/4" x 8"    1-1/4" x 8"

*Custom prefinishing available.*



# INSTALLATION

## Rabbeted Butt Siding

① Before installing butt siding, evenly space the boards between the soffit and the foundation. Trim the top board if needed. Leave 1/8" air space between courses to allow the cedar to contract and expand. Never nail butt and tip together. See *close-up detail*.

Begin the installation of the bottom course first. Space nails at a maximum of 24" on center and ② make sure nails penetrate 1-1/2" into solid wood.

See *Fittings & Joints* for needed instructions regarding nailing, staggering, and weatherproofing siding, joints, and ends.

### Construction Cross Section

- ③ Stud
- ④ Sheathing
- ⑤ DuPont™ Tyvek® DrainWrap™

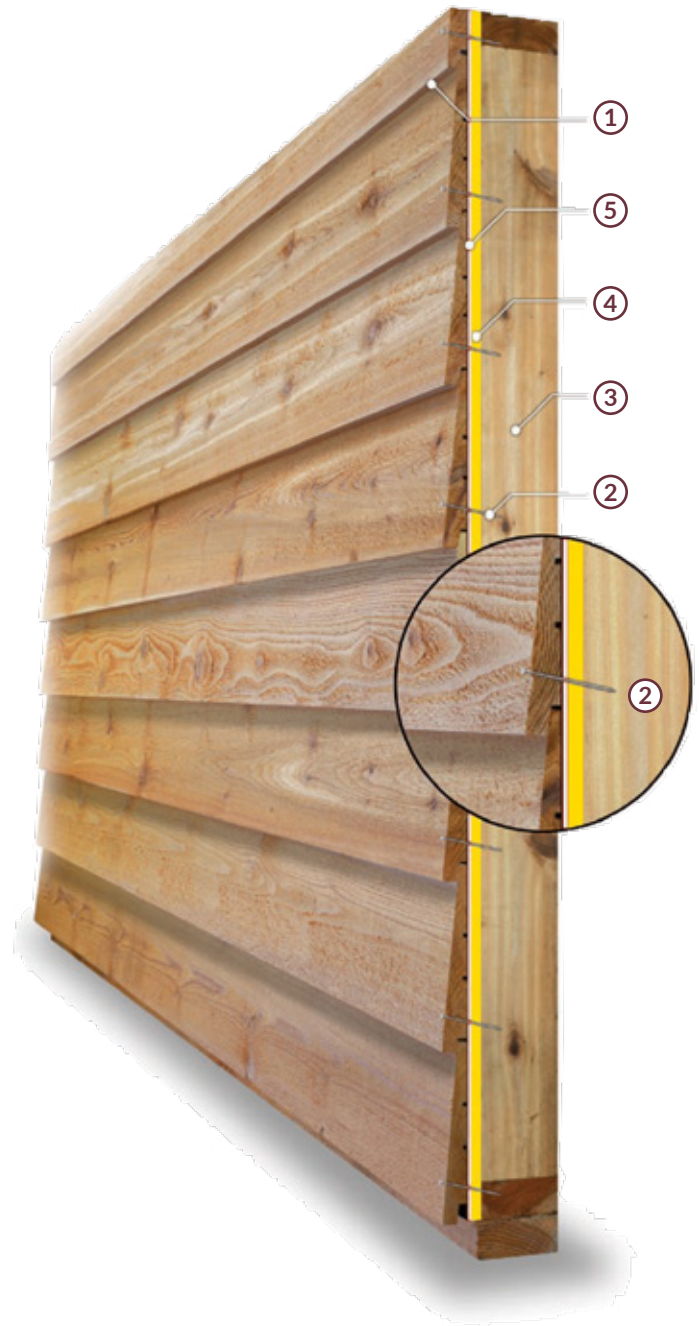

# INSTALLATION

## Bevel Siding

① Before installing bevel siding, evenly space the boards between the soffit and the foundation. Trim the top board if needed. Allow a minimum overlap of no less than 3/4" and never more than 1-1/4". Never nail butt and tip together. *See close-up detail.*

② Begin the installation of the bottom course first, using blocks ②<sup>a</sup> to get the siding at a proper angle. Space nails at a maximum of 24" on center and make sure nails penetrate 1-1/2" ②<sup>b</sup> into solid wood. *See close-up detail.*

Leave a small gap between the nails of one course and the siding below, to allow cedar to contract and expand. *See close-up detail.*

See *Fittings & Joints* for needed instructions regarding nailing, staggering, and weatherproofing siding, joints, and ends.

### Construction Cross Section

- ③ Stud
- ④ Sheathing
- ⑤ DuPont™ Tyvek® DrainWrap™

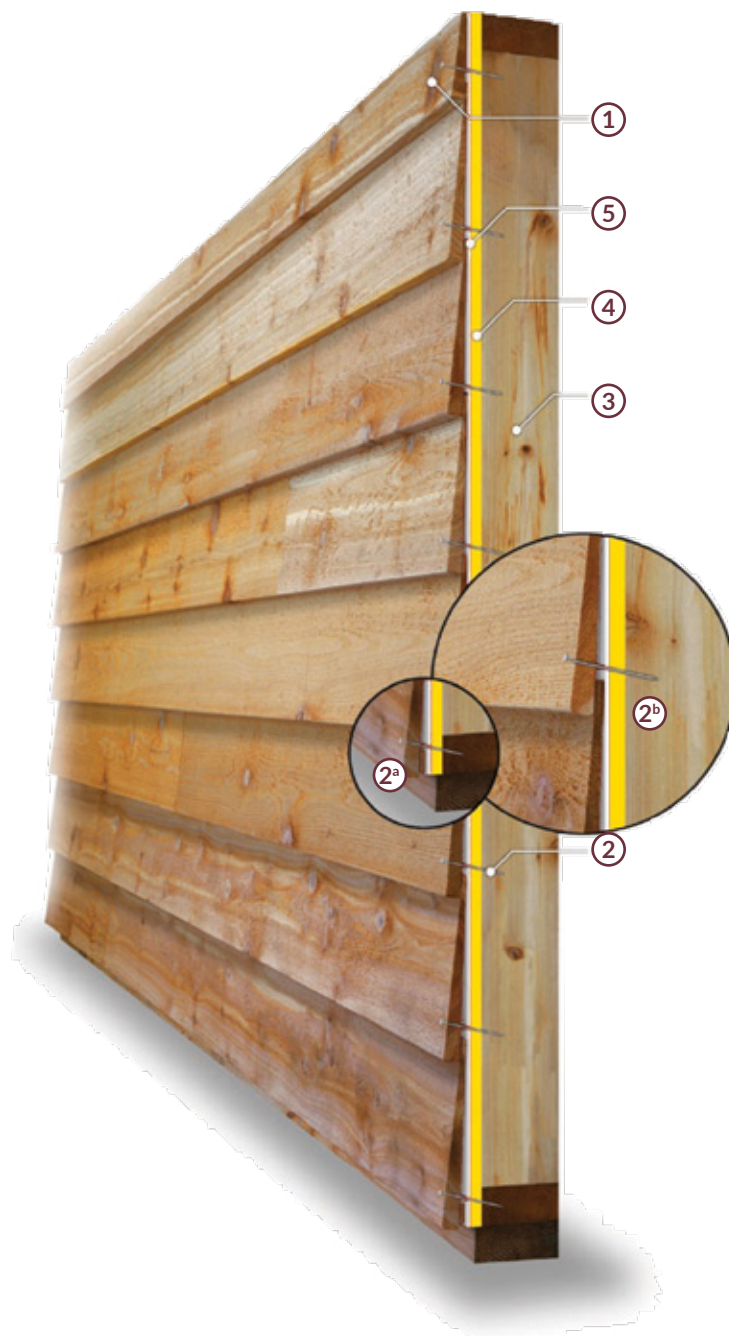



# INSTALLATION

## Tongue & Groove Siding

Install Tongue & Groove Siding either horizontally or vertically.

### For Horizontal Applications:

---

Start at the bottom and work up with the grooved edges facing downward. ① Siding up to 6" wide should be toe-nailed through the base of each tongue to allow the groove of the next piece to slip over it. Do not drive nails straight in. For windy conditions, outdoor siding should be face-nailed using two nails.

Ceiling applications should be nailed to joists at a maximum of 24" on center. ② Sufficient penetration is imperative. Make sure nails penetrate 1-1/2" into solid wood.

### For Vertical Applications:

---

Start at one corner with the grooved edge towards your left. Make sure that the first board installed is plumb. The grooved edge of the first board may need to be trimmed to ensure a flush fit. Nail siding to horizontal blocking lines installed between studs or to furring strips. Pieces up to 6" can be blind-nailed while larger pieces, and where conditions are windy, should be face-nailed as described above.

### Construction Cross Section

---

- ③ Stud
- ④ Sheathing
- ⑤ DuPont™ Tyvek® DrainWrap™

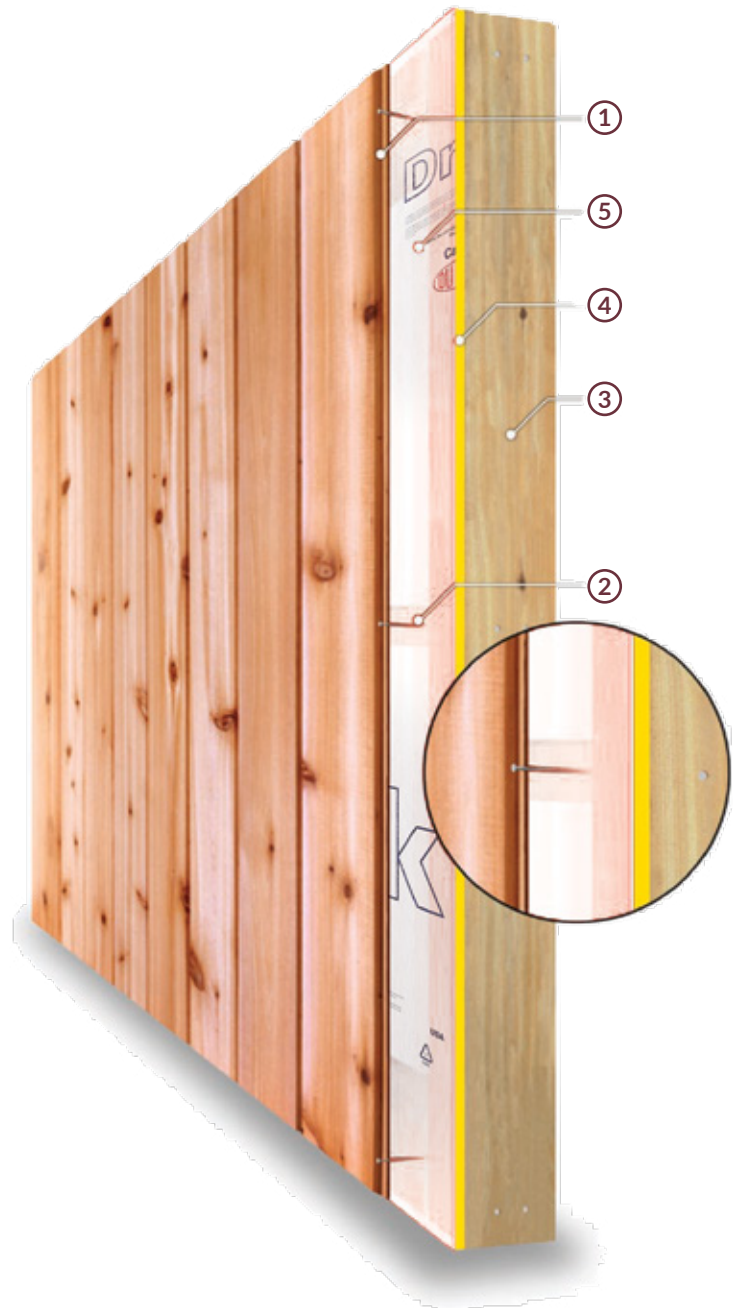

# INSTALLATION

## Channel Siding for Vertical Application

Vertically applied channel siding, up to 6" wide, can be attached with one face-nail into furring strips or studs. Wider siding or applications in windy areas should be face-nailed using two nails. Make sure that the first board is installed correctly by using a vertical plumb line or a level. ① You may have to trim the edges of the first and last boards to ensure a tight-flush fit and even-looking finish.

Start at one corner with the channel edge towards your right. ② Nail the siding to horizontal blocking lines installed between studs or to furring strips. See close-up detail. Make sure nails penetrate 1-1/2" into solid wood and face-nail only. Fasteners should be spread far enough apart from each channel piece to allow them to contract and expand independently; avoid nailing channels together.

### For Horizontal Applications:

Use pattern 105. Start at the bottom and work up with the channel tongue facing upward and nail as described above.

### Construction Cross Section

- ③ Stud
- ④ Sheathing
- ⑤ DuPont™ Tyvek® DrainWrap™

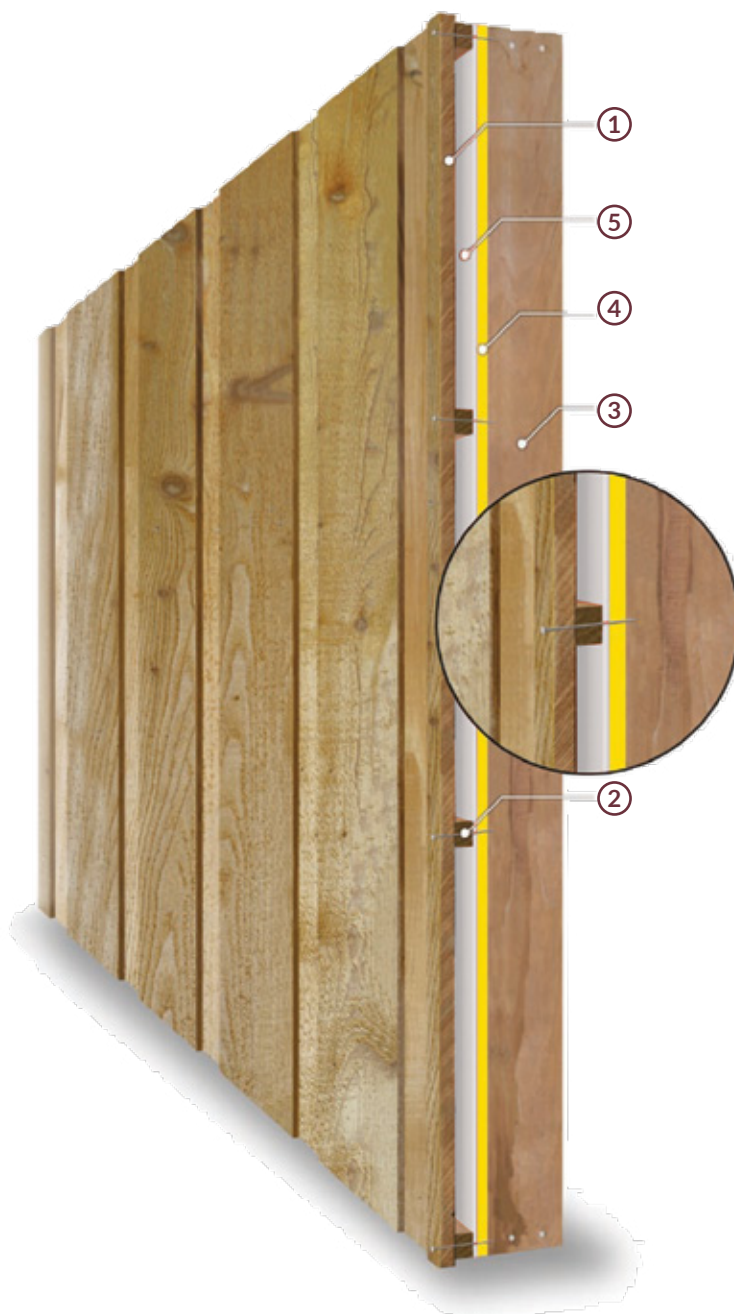



# INSTALLATION

## Fittings & Joints

① Butt-joints between boards should be mitered and placed over studs. Fit them snugly to other pieces, to trim, and to flashing. Caulk all ends. *Note the 1/8" air gap in the close-up detail.*

### Construction Cross Section

- ② Stud/Wall Framing
- ③ Sheathing
- ④ DuPont™ Tyvek® DrainWrap™



## Flashing Installation

Proper wall construction and siding installation are required to prevent water from seeping behind the siding into the wall and roof spaces. Where the roof meets the siding and trim, always use flashing. Flashing is meant to direct water away from walls.

① Keep trim and siding a minimum of 1" above the roof to avoid wicking.

② The photo (right) shows how a metal roof meets the siding. Note that the metal roof is bent up to go behind the siding. For shingle roofing, the flashing goes behind the siding to allow water to drain on top of the shingles.

Flash above doors and windows where different buildings and finishing materials meet. Tilt flashing so water drains away from the wall. Do not caulk where the flashing and trim meet. Never use caulking instead of flashing.

For ground-floor skirt board applications, flash above the skirt boards and keep the board off the ground at least 6". For a second-floor application, flash above and below the windows and band boards.

Flash fascia boards to prevent water from getting underneath roofing shingles or behind soffits and fascia boards.





## Nail Types & Wall Construction

### Nails

Use only hot-dipped galvanized, stainless steel, or aluminum nails, as recommended by ASTM.A.153. These nail types are resistant to corrosion and compatible with Western Red Cedar. Other types of fasteners, like copper, can cause stains and streaks in the siding. If the siding is to be finished with transparent or semi-transparent stain, use No. 304 stainless steel nails. For seacoast exposures, use No. 316 nails.

### Nail Type, Size, and Spacing

Split-less siding nails have thin shanks and blunt points to reduce the risk of splitting the siding. For greater hold, nails with a ring or spirally threaded shanks should be used. ① Nails with textured heads reduce any glossy appearance when finishing. Nails should be driven carefully. Heavy nailing can distort the wood and may cause splitting. If a nail is countersunk, fill the hole with an outdoor putty that can be stained or painted. To reduce splitting, pre-drill holes at mitered corners, near edges, and at ends.

Appropriate nail size depends on the type and thickness of the siding application. Use nails that are long enough to go through the sheathing and insulation and penetrate at least 1-1/2" into solid wood. ② Indicates minimum nail lengths for fastening various thicknesses of cedar siding over wood sheathing. Siding must always be nailed to studs.

### Wall Construction

Western Red Cedar siding should be installed to framing. House-wrap or permeable building paper will ensure that the siding has a long life.

Cedar siding must be nailed to the framing, furring, or to blocking between framing members.

③ Shows lumber sizes and spacing for furring strips.

Siding should be fastened to each stud or furring strip with nails spaced at a maximum of 24" on center.

Nail placement depends on the siding pattern and width. Avoid restricting the natural movement of each piece to prevent splitting.

②

Minimum Nail Lengths		
Siding Type	Siding Thickness	Nail-Type & Length Ring or Spiral Shank
Bevel	1/2"	2" 6d
	5/8"	2" 6d
	3/4"	2-1/4" 10d
	7/16" - 15/16"	3" 10d
	5/4" Rabbeted	3" 10d
Boards, T&G and Channel	5/8"	2" 6d
	3/4"	2" 6d
	7/8"	2-1/4" 7d
Battens for Board and Batten	5/4"	3" 10d

For applications over foam sheathing, add the thickness of the foam to the tabulated nail length.



③

Spacing for Blocking & Furring		
	Min Lumber Size	Max Spacing Center-to-Center
Blocking	2" x 2"	24"
Furring Over Plywood/OBS Sheathing*	1" x 2"	24"
Furring Over Masonry Walls	2" x 2"	24"

Furring must be securely fastened to studs.

\*Can be used in damp and severe climates to form an airspace between the siding and sheathing.

# TIGHT-KNOT WESTERN RED CEDAR

## Product Specifications

To calculate the siding needed, multiply all walls by their length times their height. Subtract the square footage of all window and door openings. Multiply the above numbers by the board-foot (BF) factor shown in this guide.\* Lastly, add ten percent to allow for trim.

### 11/16" Tongue & Groove STK Paneling

Normal	Thickness	Width	Face	BF Factor*
1" x 4"	11/16"	3-3/8"	3"	1.33
1" x 6"	11/16"	5-3/8"	5"	1.20
1" x 8"	11/16"	7-3/8"	7"	1.19

### Green & Kiln-Dry STK Channel Rustic Siding

Normal	Thickness	Width GRN	Face KD	BF Factor*
1" x 6"	11/16"	5-1/2"	5-3/8"	1.27
1" x 8"	11/16"	7-3/8"	7-1/8"	1.21
1" x 10"	11/16"	9-3/8"	9-1/8"	1.16

### 5/8" STK Bevel Siding—Plain Butt

Normal	Tip	Butt	Width	BF Factor*
1" x 6"	1/8"	9/16"	5-1/4"	1.33
1" x 8"	1/8"	9/16"	7-1/4"	1.23

### 11/16" STK Bevel Siding—Plain and Rabbeted

Normal	Tip	Butt	Width	BF Factor*
11/16" x 6"	1/8"	11/16"	5-1/4"	1.33
11/16" x 8"	1/8"	11/16"	7-1/4"	1.23
11/16" x 10"	1/8"	11/16"	9-1/4"	1.18

### 3/4" STK Bevel Siding—Plain and Rabbeted

Normal	Tip	Butt	Width	BF Factor*
3/4" x 6"	3/16"	3/4"	5-1/4"	1.33
3/4" x 8"	3/16"	3/4"	7-1/4"	1.23
3/4" x 10"	3/16"	3/4"	9-1/4"	1.18

### 5/4" STK Bevel Siding—Rabbeted

Normal	Tip	Butt	Width	BF Factor*
1" x 6"	1/4"	1-1/32"	5-1/4"	1.33
1" x 8"	1/4"	1-1/32"	7-1/4"	1.23
1" x 10"	1/4"	1-1/32"	9-1/4"	1.18



# TIGHT-KNOT WESTERN RED CEDAR



## 11/16" T&G PANELING

1" x 4" 3" Face



1" x 6" 5" Face



1" x 8" 7" Face



## CHANNEL RUSTIC SIDING | Green & Kiln-Dried

1" x 6"



1" x 8"



1" x 10"



## 5/8" STK BEVEL SIDING | Plain Butt

1" x 6"



1" x 8"



## 11/16" STK BEVEL SIDING | Plain & Rabbeted

1" x 6"



1" x 8"



1" x 10"



\*Cross section diagrams not shown to-scale.

# TIGHT-KNOT WESTERN RED CEDAR

## 3/4" STK BEVEL SIDING | Plain & Rabbeted

1" x 6"



1" x 8"



1" x 10"



## 5/4" STK BEVEL SIDING | Rabbeted

1" x 6"



1" x 8"



1" x 10"



## S1S2E 8' to 20' | Random Lengths

1" x 6"



1" x 8"



1" x 10"



1" x 12"



\*Cross section diagrams not shown to-scale.



# DIMENSIONAL POSTS & TIMBERS



## 2/BTR Rough Sawn Appearance

6" x 6" Green

Available in Lengths 8' - 16'

## STK S4S S-Green-Graded 4 sides

4" x 4"

Available in Lengths 8' - 12'



## 2/BTR S1S2E | Kiln-Dried Appearance

2" x 4"	294 pc/unit	2" x 10"	105 pc/unit
2" x 6"	189 pc/unit	2" x 12"	84 pc/unit
2" x 8"	126 pc/unit		

Available in Lengths 8' - 16'

## 2x2 Cedar Balusters

C/Btr S4S Dry-Clear	420 pc/unit
2" x 2" x 8' Cedar Posts	420 pc/unit

\*Custom prefinishing available.

# PRAIRIE WOOD CEDAR



Billings, MT

## S1S2E | Kiln-Dried Rustic Grade Inland Red Cedar

1" x 3"	224 pc/unit	1" x 10"	70 pc/unit
1" x 4"	182 pc/unit	1" x 12"	56 pc/unit
1" x 6"	112 pc/unit	1" x 6" T&G	126 pc/unit
1" x 8"	84 pc/unit	1" x 8" Channel	84 pc/unit



Raw Material



# PRAIRIE WOOD CEDAR

## Living Finish

Prairie Wood Stain colors are "Living Finishes" and are designed to weather and change appearance with exposure to exterior conditions and sunlight. Because of the chemical nature of the treatment applied, and the varying composition of cedar products, no warranty is expressed or implied with regards to the nature or consistency of the color and are NOT representative of the final appearance of the product.



## Homestead Grey

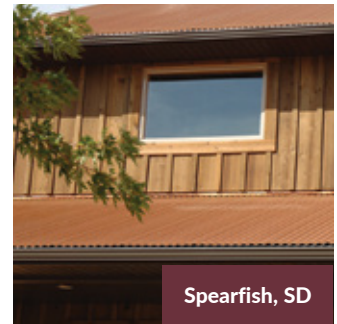
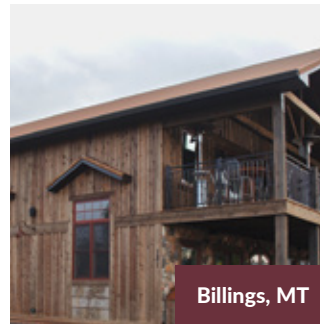

## Custom Stain

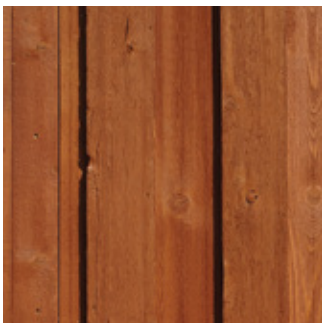

# PORT ORFORD CEDAR DECKING

*Grown and manufactured with pride in the Great Northwest, Port Orford Cedar is a beautiful wood that will age with grace.*

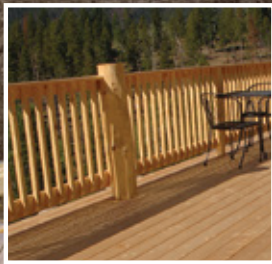

## SUPERIOR MANUFACTURING

Decking is planed on our 16-knife planer to give the product an impeccable smoothness and soft luster. Since the turn of the century, the Johnson Family—the founders and owners of C&D Lumber Co.—has been known for their work ethic, respect for natural resources and love of Port Orford Cedar in America.





# PORT ORFORD CEDAR DECKING



Homestake Pass, MT

40% stronger and 100% more beautiful! Port Orford Cedar is rapidly becoming the first choice of architects, builders, and homeowners who appreciate the best decking available.

## Legendary Durability & Long Life

Historically preferred for marine applications such as docks and fine boat building.

## Beautiful Color & Appearance

Remains smooth with no raised grain. Gives unlimited color options when staining.

## Exceptional Strength

45% stronger than Redwood and Western Red Cedar in impact bending and 30% stronger in crushing strength.

Product	pc/unit	Actual finished size
2" x 6" Appearance Plus	128	1-7/16" x 5-7/16"



# PORT ORFORD CEDAR DECKING



- 45% stronger in impact bending tests than Western Red Cedar or Redwood
- 30% stronger in crushing strength
- 20-25 year post-in-ground testing
- Cream-white hue ages to a stately silver grey
- Historically preferred for marine applications, such as docks and boat buildings

## Smooth Finish

Extra care is taken in producing an exceptionally smooth finish when surfacing our decking. Customers can walk barefoot or let the kids play without worrying about even a sliver. The light color of this decking makes it easy to tint or stain so that it will fit any decor, without hiding the natural beauty and grain of the wood.

## Decay Resistance

Port Orford Cedar decking materials are naturally decay-resistant. Both woods have natural oils that protect against rot and decay, while other woods require chemical treatments to match the natural longevity of our products.



## INSTALLATION HINTS:

**Fastening:** When nailing or using screws at the extreme end of a board, you may wish to pre-drill to reduce the possibility of splitting. Do not over nail or set nails so deep as to create a hole which could hold water or dirt.

**Staining and Finishing:** A penetrating clear or semi-transparent stain which contains ultra violet blockers provides the greatest level of protection from the elements. Paints and solid stains are not recommended. Light colors are recommended over

dark shades because they do not absorb heat as readily. Although each manufacturer of stain provides careful guidance for their particular products, some basic rules generally hold true:

- After installation, allow decking to go untreated for 30 days, allowing pores to open
- Test your selection of stain on a sample area
- Clean deck thoroughly prior to staining
- Apply when surface of deck is between 40° to 90°



Whitehall, MT

## CEDAR SPLIT RAIL FENCING



Billings, MT



Whitehall, MT



Colorado Springs, CO

### Posts

5'4" Post	2-Hole	End	72 pc/unit
5'4" Post	2-Hole	Line	72 pc/unit
5'4" Post	2-Hole	Corner	68 pc/unit
6'3" Post	3-Hole	End	72 pc/unit
6'3" Post	3-Hole	Line	72 pc/unit
6'3" Post	3-Hole	Corner	68 pc/unit

### Rail | Standard Weight

8' Rail	160 pc/unit
10' Rail	155 pc/unit



# CEDAR FENCING



## Cedar Fencing

1" x 6" x 6'	Dog Ear Top
1" x 6" x 6'	Flat Top

#3	No Hole	3/4"	Rough 4 Sides
#3	No Hole	13/16"	S1S2E

2" x 4" x 8'	Rail	Rough Cedar
4" x 4" x 8'	Post	Rough Cedar

1" x 6" x 6'	IRC	Cedar	S1S2E 2/Btr NH
1" x 6" x 6'	IRC	Cedar	S1S2E DE or FT



Raw material

Custom prefinishing available.



# CEDAR SHAKES & SHINGLES

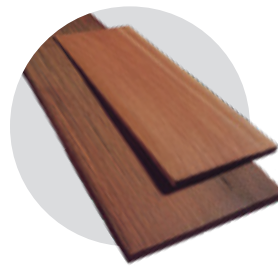

Raw Product

## Shake & Shingle

- #1 Medium H/S
- #1 Heavy H/S
- #1 5/8" Tapersawn
- #1 16" W.R. Shingles
- #2 16" W.R. Shingles
- #1 Tapersawn Ridge
- #1 16" Shingle Ridge

## Fire-Treated Class-B

- #1 Medium H/S
- #1 Heavy H/S
- #1 16" W.R. Shingles
- #1 Ridge

## Specialty Shake & Shingle\*

- 1-1/4" x 48" Jumbo H/S Shakes Fire Treated or Raw
- \*Special Order Only*

# CERTIGRADE® RED CEDAR SHINGLE



Buffalo Bill Museum | Cody, WY

This type of smooth sawn, architecturally uniform cedar shingle is preferred for its natural and tailored appearance and is used on traditional, modern, and non-residential structures. For use on roofs and sidewalls.

## CERTIGRADE® Number 1 Blue Label

The premium grade of shingles for roofs and sidewalls. These top-grade shingles are 100% heartwood, 100% clear, and 100% edge grain. Available in 16", 18", or 24" lengths.

Lengths 16" (Fivex), 18" (Perfection), 24" (Royal); width 4" minimum, on 24" and 3" on 16" and 18"; thickness of 16" is 5/2" (5 butts together measures 2" thick), 18" is 5/2, 1/4" thick, 24" is 4/2" thick. Clear heartwood; 100% edge grain; no defects.

### *Recommended Use:*

*For walls and roofs on 3:12 pitch and steeper where a premium quality product is desired.*

## CERTIGRADE® Number 2 Red Label

A good grade for many applications. No less than 10" clear on 16" shingles, 11" clear on 18" shingles and 16" clear on 24" shingles. Flat grain and limited sapwood are permitted in this grade.

Lengths 16", 18", 24"; thickness of 16" is 5/2", 18" is 5/2-1/2", 24" is a 4/2"; width 4" minimum. Face must be 10", 11" and 16" clear or better on 16", 18", and 24" shingles, respectively.

### *Recommended Use:*

*For walls and roofs on 3:12 pitch and steeper where a high quality product is desired.*

# CERTIGRADE® RED CEDAR SHINGLE

**WEATHER EXPOSURE TABLE**

Product	Pitch	Length		
		16"	18"	24"
Number 1 Blue Label®	3:12 – 4:12	3-3/4"	4-1/2"	5-3/4"
	4:12 – 12:12	9-3/8"	5-1/2"	7-1/2"
Number 2 Red Label®	3:12 – 4:12	3-1/2"	4"	5-1/2"
	4:12 – 12:12	4"	4-1/2"	6-1/2"
Number 3 Black Label®	—	3"	3-1/2"	5"
		3-1/2"	4"	5-1/2"

- Class A, B & C fire ratings may be obtained by specifying Certi-Guard® pressure impregnated fire-retardant treatment, on number 1 grade product.
- Certi-Last® pressure impregnated preservative treatment is available for added longevity.
- Contact the treatment company for treatment warranty information, accessory product requirements (including recommended fastener types), and application details for treated cedar material.
- Certi-Label™ cedar shake and shingle hip and ridge units are manufactured by members of the Cedar Shake & Shingle Bureau and graded in accordance with UBC Standards No. 15-3 and 15-4 and/or CSA 0118.1.
- This is only a product description necessary for selection of materials and grades. For a new roof construction manual and/or wall manual please contact: info@cedarbureau.com.

## CERTIGRADE® Number 3 Black Label

A utility-grade for economy applications. Face must be 6" clear on 16", 18", and 10" clear on 24" shingles. Unlimited sapwood and flat grain allowed. Limited knots and defects above the clear portion.

**Recommended Use:**

*For walls and roofs on 3:12 pitch and steeper where an economy product is acceptable.*

## CERTIGRADE® Undercoating Grade

A utility grade for undercoating of double coursed sidewalls only. Not a roofing material and not to be used as a starter course for roofs.

Lengths: 16", 18", thickness 5/2" and 5/4"-1/4" respectively. Width: 2-1/2" minimum. Unlimited defects, flat grain, and sapwood.

**Recommended Use:**

*For walls and roofs on 3:12 pitch and steeper where a premium quality product is desired.*



# CERTI-SPLIT® & CERTI-SAWN® SHAKES

## CERTI-SPLIT® Hand Split and Resawn Shakes

**Hand-Split:** These shakes have split faces and sawn backs. Available in Premium Grade or Number 1 Grade.

**#1 Grade:** Lengths 24", thickness 3/8", 1/2" (medium) and 3/4" (heavy) minimums. Width 4" minimum. Clear heartwood; 20% maximum flat grain in each bundle.

*Recommended Use:*

*For walls and roofs on 4:12 pitch and steeper where high quality appearance and performance are desired.*

Specifications			
Size	Maximum Weather Exposure	Wall Exposure	
		Single Course	Double Course
18"	10" max	8"	14"
24"	7-1/2" max (5" per UBC).	10-1/2"	18"

## CERTI-SAWN® Hand Split and Resawn Shakes

**Tapersawn Shakes:** These shakes are sawn both sides. Premium and #1 Grades are the most common. Premium Grade is 100% edge grain, 100% clear and 100% heartwood. #1 Grade allows up to 20% flat grain in each bundle. #2 and #3 Grades are also available.

**#1 Grade:** Nominal length 18" and 24" shakes shall be of random widths; minimum width shall be 3 1/2". Taper sawn shakes less than 4" in width shall not constitute more than 5% of each bundle. Thickness shall be nominal 5/8" of 3/4" with a minus tolerance of 1/16" in 10% of the bundle. Face 100% clear. Flat grain 205 maximum per bundle. 1/8" sapwood allowed to exposure line. Additional sapwood permitted above that point.

*Recommended Use:*

*For walls and roofs on 4:12 pitch and steeper where high quality appearance and performance are desired.*

Specifications			
Size	Maximum Weather Exposure	Wall Exposure	
		Single Course	Double Course
18"	10" max	8-1/2"	14"
24"	7-1/2" max (5" per UBC).	11-1/2"	18"

# CERTIGROOVE® RE-MANUFACTURED

## CERTIGROOVE® Machine Grooved Shakes

---

Machine Grooved Shakes are manufactured specifically for exterior and interior wall surface uses. They are a low maintenance product that adds beauty, texture, durability, and insulating qualities to either new construction or remodeling and renovation of existing structures.

Machine grooved for a shake texture from Number 1 Grade Blue Label Certigrade® red cedar shingles, trimmed for parallel edges with butts sawn at right angles. Finished: Natural, primed white, primed grey, or special order colors.

Shingle Length
16"
18"
24"

## CERTIGROOVE® No. 1 Grade, Blue Label:

---

Lengths: 16", 18", 24"; width 4" minimum; thickness of 16" is 5/2" (5 butts together measures 2" thick), 18" is 5/2 - 1/2" thick, 24" is 4/2" thick. Clear heartwood: 100% edge grain; no defects.

### *Recommended Use:*

*For exterior and interior walls where a premium quality product is desired*

Shingle Length	Maximum Weather Exposure	
	Single Course	Double Course
18"	7"	12"
24"	8"	14"

# EXTERIOR DOORS



DOORS



6826 Shown in Knotty Alder

Our Builders Choice wood doors come in a wide assortment of species, sizes, and architectural styles to fit your needs. Add curb appeal and value to your home by upgrading its look with our decorative entry doors.



3083 Shown in Knotty Alder



# EXTERIOR DOORS

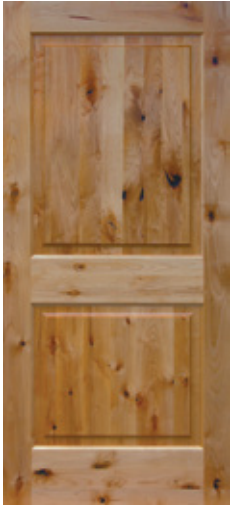

3082



3083



5182



5662



6826

## Stile and Rail Exterior Doors

6826	Craftsman	2 Panel 6 Lite	KA
5662	Craftsman	2 Panel 6 Lite	H
5182	Traditional	1 Panel Half Lite	KA
3083	Traditional	2 Panel Arch Top	KA
3082	Traditional	2 Panel	KA



Knotty Alder



Hemlock

**H** Hemlock

**KA** Knotty Alder

\* For a complete offering of doors and glazing options, please refer to the Builders Choice Stile & Rail Catalog at [www.orepac.com](http://www.orepac.com).

# INTERIOR DOORS



DOORS

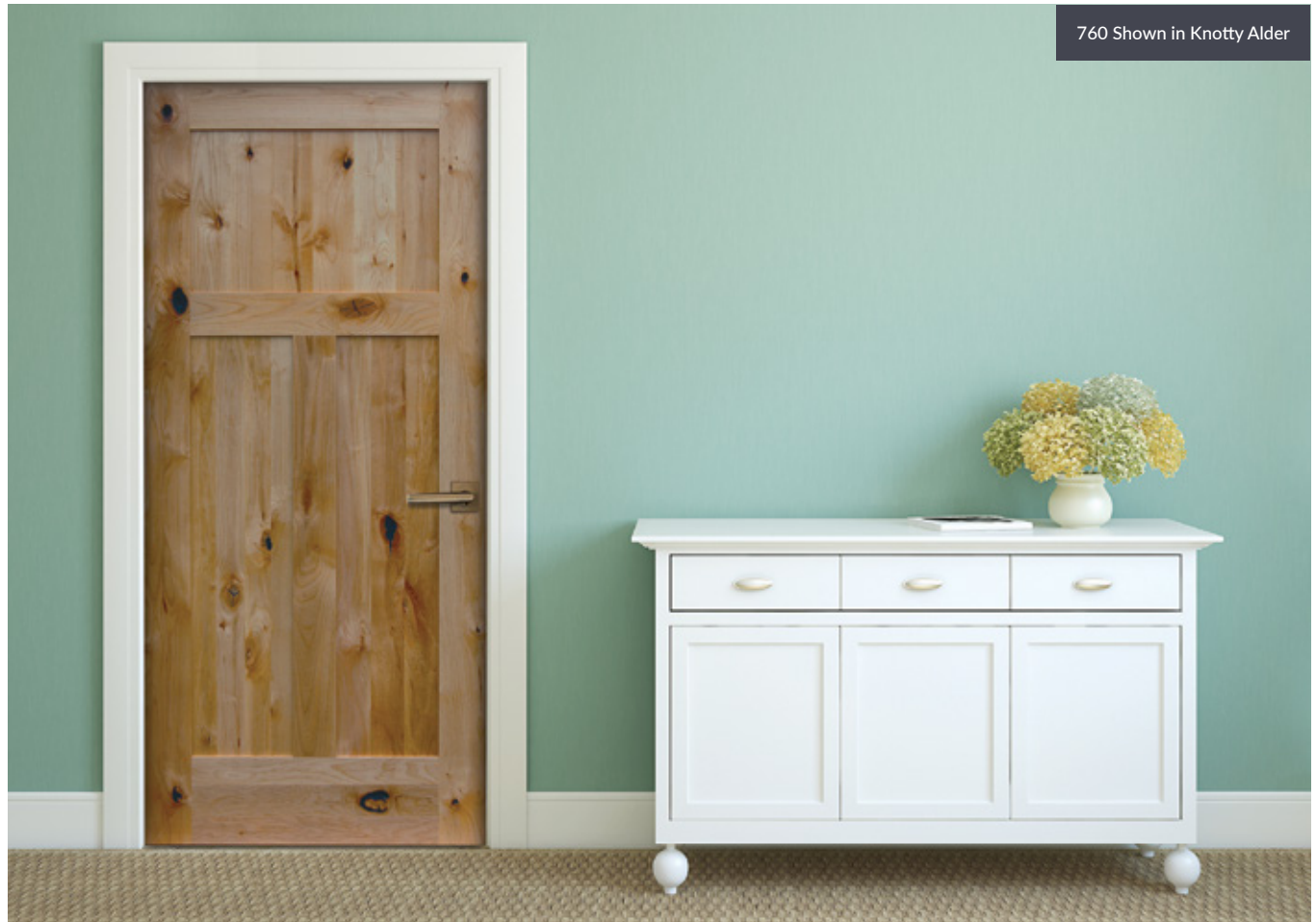

Knotty Alder



Knotty Pine



Clear Pine

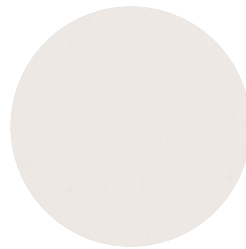

Primed

# INTERIOR DOORS



44

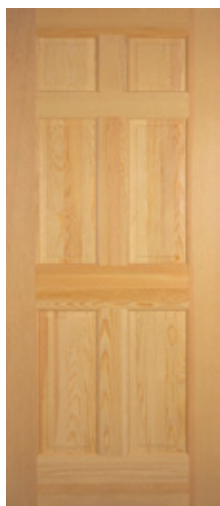

66

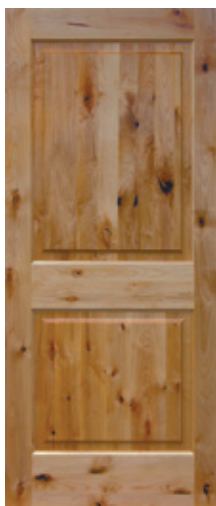

82

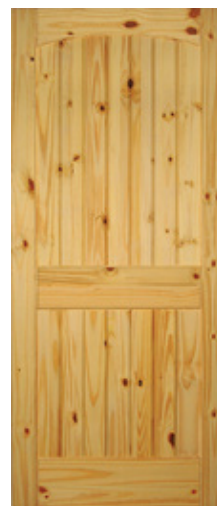

83V



83



720



755

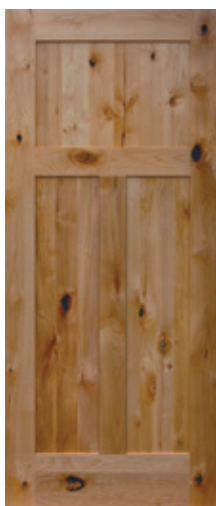

760

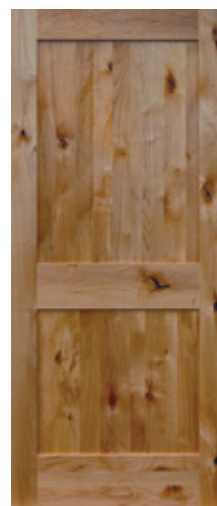

782

- KA Knotty Alder
- KP Knotty Pine
- CP Clear Pine
- P Primed

## Interior Doors

44	Craftsman	2 Panel 6 Lite	<span style="color: orange;">CP</span>	720	Craftsman	1 Panel	<span style="border: 1px solid black; border-radius: 50%; padding: 2px;">P</span>
66	Craftsman	2 Panel 6 Lite	<span style="color: orange;">CP</span>	755	Craftsman	5 Panel	<span style="color: green;">KA</span>
82	Traditional	1 Panel Half Lite	<span style="color: green;">KP</span>	760	Craftsman	3 Panel	<span style="color: green;">KA</span>
83	Traditional	2 Panel Arch Top	<span style="color: green;">KA</span>	782	Craftsman	2 Panel	<span style="color: green;">KA</span>
83V	Traditional	2 Panel Arch Top V-Groove	<span style="color: green;">KP</span>				

\* For a complete offering of doors and glazing options, please refer to the Builders Choice Stile & Rail Catalog at [www.orepac.com](http://www.orepac.com).





ERB720V Shown in Knotty Alder

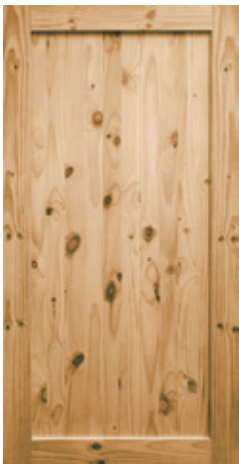

ERB720V



ERBZ

### Barn Doors

- ERB720V      1 Panel V-Groove      KA
- ERBZ            "Z" Style                              KA

### Barn Track Hardware Kit (Optional)

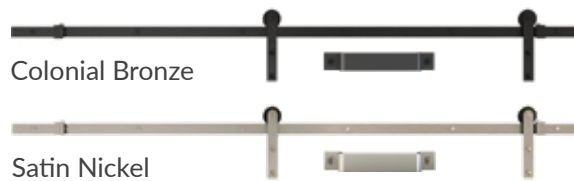

Colonial Bronze

Satin Nickel

\* For a complete offering of doors and glazing options, please refer to the Builders Choice Stile & Rail Catalog at [www.orepac.com](http://www.orepac.com).

# INTERIOR BIFOLD DOORS



782BF



755BF

## Traditional Panel Bifold Interior Doors

755BF	5 Panel	<b>H</b>
782BF	2 Panel	<b>KA</b>



Knotty Alder



Hemlock

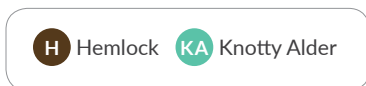

\*For a complete offering of doors and glazing options, please refer to the Builders Choice Stile & Rail Catalog at [www.orepac.com](http://www.orepac.com).

# DOUGLAS FIR BEAMS



Billings, MT

DOUGLAS FIR

- #1/Better
- Premium Product
- Selected for Appearance
- End Stamped S-Dry
- Free of Heart Center
- Free of Wane
- Kiln-Dried
- Available Resawn & S4S



\* All of Elk Creek Forest Products' Douglas Fir is now anti-stain treated to prevent staining from tannin and mold. Great for inventory. 90% FOHC

	Lengths Available					
	8'	10'	12'	16'	20'	24'
2" x 4"			•	•		
2" x 6"			•	•	•	
2" x 8"			•	•	•	
2" x 10"			•	•	•	
2" x 12"			•	•	•	
3" x 6"	•	•	•	•	•	
3" x 8"	•	•	•	•	•	
3" x 10"	•	•	•	•	•	
3" x 12"	•	•	•	•	•	
4" x 4"	•	•	•	•		
4" x 6"	•	•	•	•		
4" x 8"	•	•	•	•	•	
4" x 10"	•	•	•	•	•	
4" x 12"	•	•	•	•	•	
6" x 6"	•	•	•	•	•	
6" x 8"	•	•	•	•	•	
6" x 10"	•	•	•	•	•	•
6" x 12"	•	•	•	•	•	•
8" x 8"	•	•	•	•	•	•
8" x 10"	•	•	•	•	•	•
8" x 12"	•	•	•	•	•	•
10" x 10"				•	•	•
10" x 12"				•	•	•
12" x 12"				•	•	•



# DOUGLAS FIR BEAMS



- #1/Better
- Premium Product
- Selected for Appearance
- End Stamped S-Dry
- Free of Heart Center
- Free of Wane
- Bandsawn after Kiln Drying
- 1/2" Nominal Size



## Premium Plus Kiln-Dried Douglas Fir Timbers

2" x 4"	8'-16'	4" x 4"	8'-16'	8" x 8"	8'-26'	12" x 12"	16'-28'
2" x 6"	8'-16'	4" x 6"	8'-16'	8" x 10"	8'-26'		
2" x 8"	8'-20'	4" x 8"	8'-26'	8" x 12"	8'-26'		
2" x 10"	8'-20'	4" x 10"	8'-26'				
2" x 12"	8'-20'	4" x 12"	8'-26'	10" x 10"	16'-28'		
				10" x 12"	16'-28'		
3" x 6"	8'-20'	6" x 6"	8'-26'				
3" x 8"	8'-20'	6" x 8"	8'-26'				
3" x 10"	8'-20'	6" x 10"	8'-26'				
3" x 12"	8'-20'	6" x 12"	8'-26'				

## Premium Plus Kiln-Dried S4S Douglas Fir Timbers

6" x 6"	12', 16', 20'	8" x 8"	12', 16', 20'
---------	---------------	---------	---------------



# DOUGLAS FIR BEAMS



## Doug Fir Resawn Timbers Net Finished Sizes

	Actual Dimensions
3"	2-1/2" x 3-1/2"
	2-1/2" x 5-1/2"
	2-1/2" x 7-1/4"
	2-1/2" x 9-1/4"
	2-1/2" x 11-1/4"

	Actual Dimensions
8"	7-1/4" x 7-1/4"
	7-1/4" x 9-1/4"
	7-1/4" x 11-1/4"
	7-1/4" x 13-1/4"
	7-1/4" x 15-1/4"

	Actual Dimensions
4"	3-1/2" x 3-1/2"
	3-1/2" x 5-1/2"
	3-1/2" x 7-1/4"
	3-1/2" x 9-1/4"
	3-1/2" x 11-1/4"

	Actual Dimensions
10"	9-1/4" x 9-1/4"
	9-1/4" x 11-1/4"
	9-1/4" x 13-1/4"

	Actual Dimensions
6"	5-1/2" x 5-1/2"
	5-1/2" x 7-1/4"
	5-1/2" x 9-1/4"
	5-1/2" x 11-1/4"



Swan Valley, Idaho



Ennis, MT

DOUGLAS FIR

# DOUGLAS FIR BEAMS



## Pitch Pockets in KD Timbers

---

Very few of our timbers have pitch pockets or seams, as we avoid cutting this type of timber for our KD product line. However, our drying process will set or dry any pitch that may be present.

## Product Grading

---

All of our products are graded before and after the drying process to ensure the highest possible quality.

## Moisture Content

---

We target different moisture contents on our various products. 1" clean finish and 2" clears 10-20%, 2" fascia and 4" #2/Btr, and all #1/Btr 19%.





# STRUCTURAL BEAM POST BASES



**4" x 4" Post Base Kit #56607**



**6" x 6" Post Base Kit #56608**



**8" x 8" Post Base Kit #56609**

Post Base Plate	Qty 1	Post Base Plate	Qty 1	Post Base Plate	Qty 1
Decorative Plate	Qty 4	Decorative Plate	Qty 4	Decorative Plate	Qty 4
Hex Cap Nuts	Qty 8	Hex Cap Nuts	Qty 8	Hex Cap Nuts	Qty 8
1-3/4" OWT Timber Screws	Qty 8	2-3/4" OWT Timber Screws	Qty 8	3-3/4" OWT Timber Screws	Qty 8

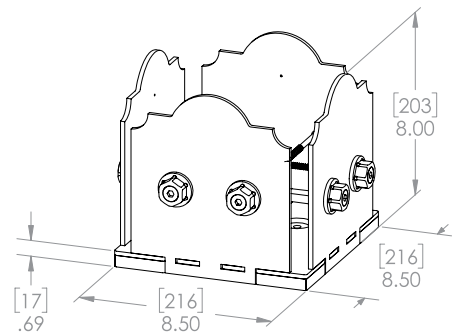
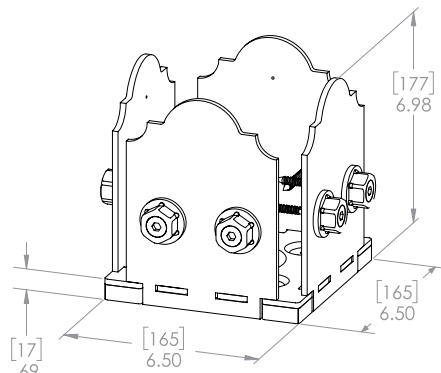
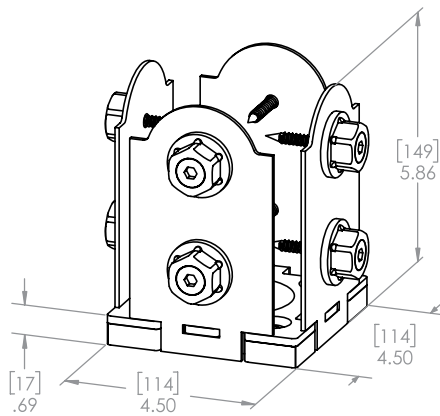

DOUGLAS FIR

## POST FASTENERS

### Specialty Fasteners

Size	Item Description	Quantity	
		Per Box	Per Case
4-6"	56649 (Bolt 4-6)	2	10
6-8"	56650 (Bolt 6-8)	2	10
8-10"	56651 (Bolt 8-10)	2	10
10-12"	56652 (Bolt 10-12)	2	10



Specialty Fastener

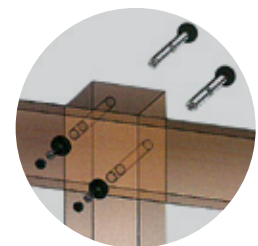

Installation

# STRUCTURAL POST-TO-BEAM TIES

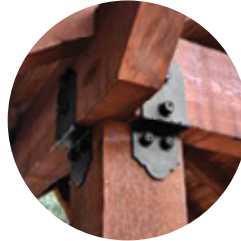

## 6" Post to Beam Kit #56635

Post Ledge Base	Qty 2
Top Cover Plates	Qty 2
Hex Cap Nuts	Qty 8
3-3/4" OWT Timber Screws	Qty 4
2-3/4" OWT Timber Screws	Qty 4

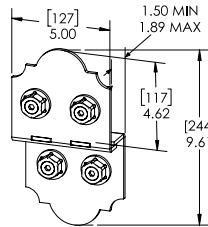

## 8" Post to Beam Kit #56610

Post Ledge Base	Qty 2
Top Cover Plates	Qty 2
Hex Cap Nuts	Qty 8
3-3/4" OWT Timber Screws	Qty 4
2-3/4" OWT Timber Screws	Qty 4

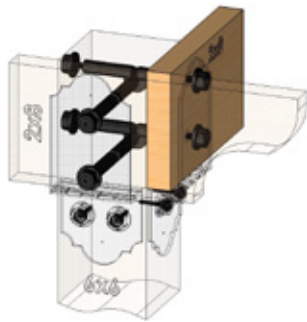
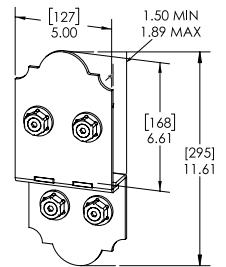

## Bolt Offset #56636 Kit

Post Ledge Base	Qty 2
Plate, Top Bolt Offset	Qty 1
Plate, Top Bolt Inline	Qty 1
Hex Cap Nuts	Qty 4
3-3/4" OWT Timber Screws	Qty 4

## Bolt Inline Kit #56637

Post Ledge Base	Qty 2
Plate, Top Bolt Inline	Qty 2
Hex Cap Nuts	Qty 4
2-3/4" OWT Timber Screws	Qty 4

DOUGLAS FIR

# DOUGLAS FIR FLOORING

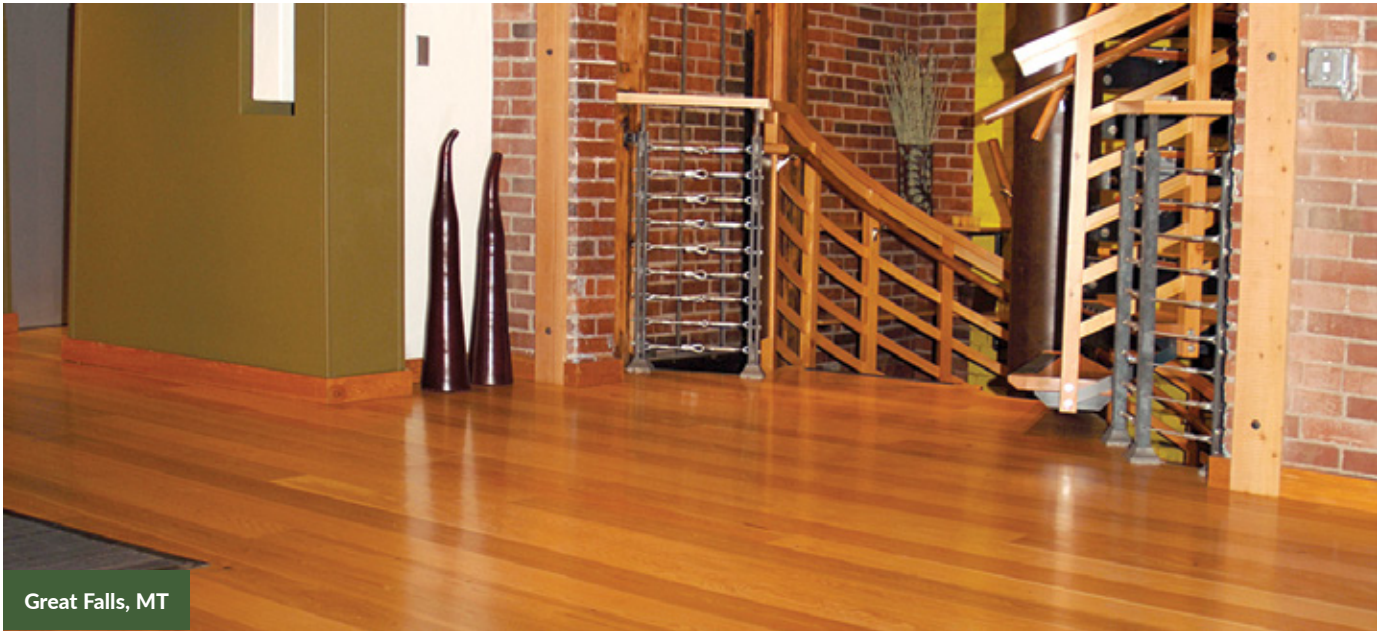

Great Falls, MT

## #2 Circular Sawn Flooring Examples



Spearfish, SD





# DOUGLAS FIR FLOORING



Jackson, WY

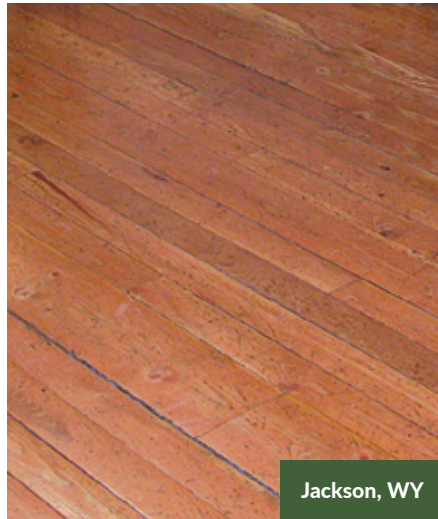

Jackson, WY

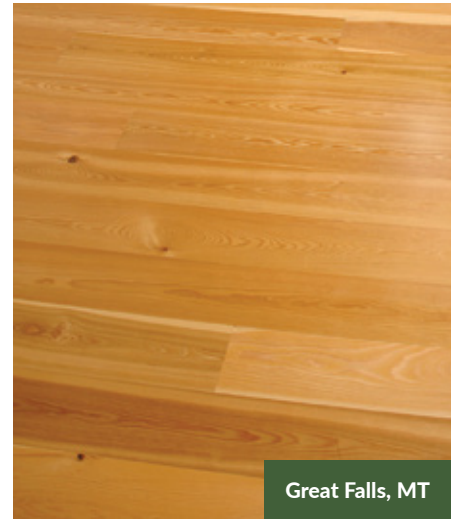

Great Falls, MT

## Douglas Fir Flooring

1" x 4"	#2 Common Fir	Smooth Face
1" x 6"	#2 Common Fir	Smooth Face
1" x 8"	#2 Common Fir	Smooth Face
1" x 4"	CVG Fir	-
1" x 4"	#2 Fir	Circular Sawn Face
1" x 6"	#2 Fir	Circular Sawn Face
1" x 8"	#2 Fir	Circular Sawn Face

## Conversion Factors

1" x 4" - 1.28    1" x 6" - 1.20    1" x 8" - 1.19

Multiply Sq. Ft. by Factor = Board feet

*All products are T&G and end matched with an approximate moisture content of 8%.*

*Circle sawn skip sand available. Wire brushed face available.*



1" x 4" CVG Fir



#2 Common



#2 Circular Sawn

# HAND-HEWN SIDING

DOUGLAS FIR

Sturgis, SD



Sturgis, SD



Sturgis, SD



Custom prefinishing available.



# HAND-HEWN SIDING



## Select Structural Dry Doug Fir Shiplap\*

2" x 10" Montana Hewn 8'-16' 50 Pc/unit

*Hand-hewn face, shiplap edges.*

## Hand-Hewn Shiplap\*

2" x 12" Montana Hewn 8'-16' 50 Pc/unit

*Hand-hewn face, shiplap edges.*

## Select Structural Dry Doug Fir Resawn 4-Sides

2" x 4"	Resawn 4-Sides	8' - 16'	48 Pc/unit
2" x 6"	Resawn 4-Sides	8' - 16'	48 Pc/unit
2" x 8"	Resawn 4-Sides	8' - 16'	48 Pc/unit
2" x 10"	Resawn 4-Sides	8' - 16'	48 Pc/unit
2" x 12"	Resawn 4-Sides	8' - 16'	48 Pc/unit

\*Also available band sawn or circle sawn texture.



# TIMBER SIDING

DOUGLAS FIR



Red Lodge, MT



**TS-2172**

1-7/16"	7"	2" Flange
1-7/16"	9"	2" Flange
1-7/16"	11"	2" Flange

*Other textures and profiles are available upon customer request.*



**TS-2122**

1-7/16"	7"	1/2" Flange
1-7/16"	9"	1/2" Flange
1-7/16"	11"	1/2" Flange

*Other textures and profiles are available upon customer request.*



**TS-2172**

*Custom prefinishing available.*

# TIMBER SIDING

## Typical Wall Cross Section

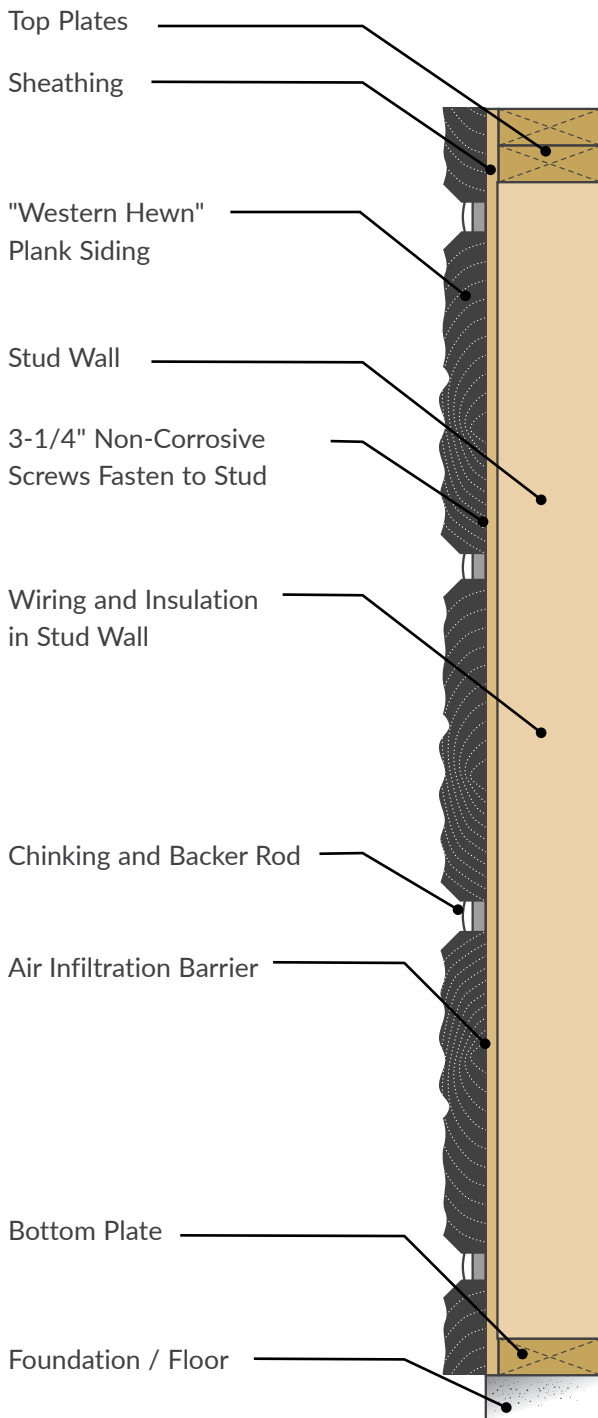

Custom prefinishing available.

## Typical Board Profile

Hand-chamfered edge, Hand-hewn face, and kerfed back

1-1/2" x 9-1/2"      Actual

1-1/2" x 11-1/2"      Actual

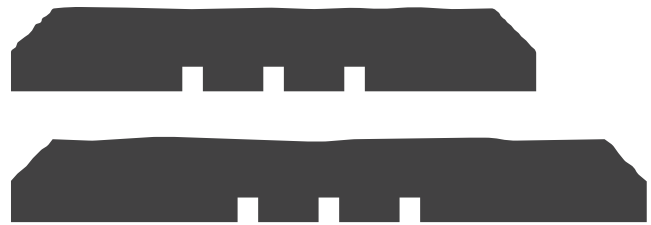

## Full Dimension Board Profile

Hand chamfered edge, Hand-hewn face, and kerfed back

2" x 10"      Full Dimension

2" x 12"      Full Dimension



# DOUGLAS FIR SAP BLEEDING



Cooney Dam, MT



Lead, SD

## Sap Bleeding

We have been in the business of making siding out of Fir Larch since 1976. Concerns with all wood siding includes shrinking, swelling, cupping, splitting, warping, and bleeding. Being a natural living product, wood siding is prone to these defects.

All siding produced by Bitterroot Valley F.P. is kiln-dried which reduces the risk of bleeding and other defects. With any natural living product, there are some defects beyond our control. A small percentage of our products are susceptible to these defects.

Setting the pitch is a term used when a board is kiln-dried and *sets the pitch*. This means the wood is brought up to a temperature of at least 140°F for at least 4 hours at

the end of the drying cycle. If the board is brought to a temperature above 140°F, it is prone to bleeding.

In certain conditions, exterior siding can vary between 60-70°F degrees warmer than the exterior air temperature when exposed to direct sunlight. The exterior temperature might be 100°F and the temperature of the siding could be as high as 170°F. Not all boards are prone to bleeding, but some boards have higher volumes of resin and sap than others. After a case study, we have found that approximately 1% of our siding is prone to bleeding.

Generally most customers will not experience noticeable bleeding. However, if bleeding does occur, it is easily removed.

Allow the pitch to harden and it can then be taken off with scraper or buffing brush. If you wish to remove the pitch while it is in liquid form, you can apply denatured alcohol by brush to loosen and wipe away the pitch.

Knowledge and education is the best tool when selling wood siding to a homeowner. Wood is a 100% natural renewable resource that has no additive and is completely organic. Education needs to be transferred from the forest to the home.



# IMPORTANT INSTALLATION INFORMATION



## Preconditioning

Wood is a hygroscopic material, equalizing it with the equilibrium moisture is always desirable prior to installation. The product should be stacked in the room which it will be installed, with each row having a separator between the layers. Never store lumber directly on the ground. Moisture-laden materials like tile and sheet rock mud should be completely dry before moving the product inside to equalize. The products should be stored for a 7 to 12 days in the same location and conditions to allow the wood to adjust to the atmospheric condition. If the product is being installed outside, make sure product does not have direct contact with the ground and is covered to not allow precipitation in, while still allowing the product to breathe. The same amount of acclimation time is required.

## Finishing

Consult your paint supplier for coating recommendations. Coating the ends, edges, back, and sides of the product after acclimation and before installation will minimize shrinkage.

## Nailing

Nails should penetrate 1" - 1.5" into the studs. Use stainless steel, high-tensile strength aluminum or hot-dipped galvanized nails. Ask your supplier for specific nailing instructions.

## Pitch

Bitterroot Valley Forest Products is not responsible for any bleeding of pitch and will not warranty any pitch problems. All siding produced by Bitterroot Valley Forest Products is kiln-dried which reduces the risk of bleeding. With any natural living product there are some defects beyond our control. Most customers will not experience bleeding

### Please Note:

All wood products expand and contract with changes in the atmospheric moisture. Complying with these instructions will minimize the movement of the wood after installation.

# ROCKY MOUNTAIN FIR FINE LINE SIDING



McAllister, MT



Big Sky, MT



Fort Smith, MT

- Easier on the budget than reclaimed
- Faster to install than reclaimed
- More consistent than reclaimed
- Dry inland fir with a circle face
- 3/4" net thickness, nominal width
- Perfect for exterior siding; board on board, board on batt, soffits, and porches
- Use anywhere a Western appearance is desired

## Bandsawn KDFL Appearance

## S1S2E Boards

## Fine Line Shiplap

2" x 4"	12', 16'	Bandsawn KDFL	1" x 4"	Circle Sawn	1" x 4" Circle Sawn
2" x 6"	12', 16'	Bandsawn KDFL	1" x 6"	Circle Sawn	1" x 6" Circle Sawn
2" x 8"	16', 20'	Bandsawn KDFL	1" x 8"	Circle Sawn	1" x 8" Circle Sawn
2" x 10"	16', 20'	Bandsawn KDFL	1" x 10"	Circle Sawn	
2" x 12"	16', 20'	Bandsawn KDFL			



Salt River

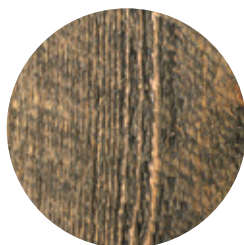

Hoback

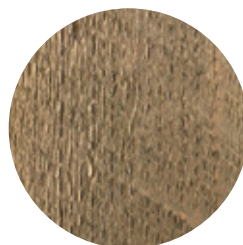

Moccasin



Coffee Creek



Saw Tooth



Wind River



Tobacco Root



Silver Creek

Custom prefinishing available upon request.

# ASPHALT SATURATED ORGANIC FELT



ROOF PROTECTION

## Tamko® No. 30 18" Asphalt Saturated Organic Felt

#30 Non-UL Saturated Felt 60 Rolls/Pallet

Features a premium quality organic felt that is saturated with asphalt. Accepted for use as a water-resistant underlayment felt used in conjunction with the installation of wood shake shingles.



### Specialty Fasteners

Roll Dimensions	18" x 72'
Coverage Per Roll	1 Square
Laying Lines	8", 10"

#### Please Note:

All wood products expand and contract with changes in the atmospheric moisture. Complying with these instructions will minimize the movement of the wood after installation.





Tyvek.

# TYVEK® PROTEC™ ROOFING UNDERLAYMENTS

ROOF PROTECTION

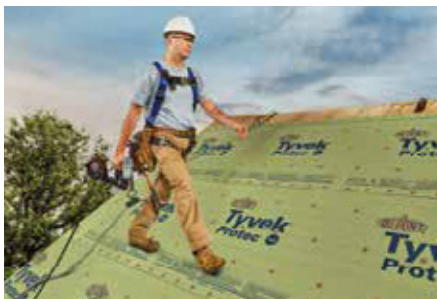

## Industry-Leading Walkability

The unique embossed pattern allows for better traction and grip while walking on the roof.



## Trusted Quality and Durability

Another innovative material breakthrough from DuPont™ Tyvek®, the leader in building envelope systems.

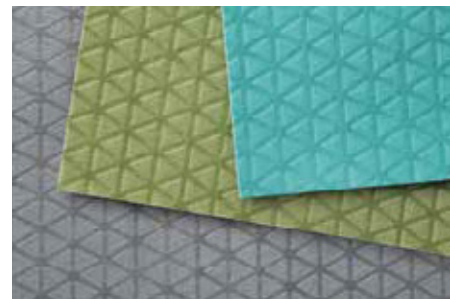

## A Family of Underlayments

Our portfolio of roofing underlayments provides choices to better meet your needs.



Tyvek.



# DUPONT™ ROOF PROTECTOR™ SYNTHETIC UNDERLAYMENT

ROOF PROTECTION



## Lightweight, Strong Protection

Excellent grip to the deck and strength of product helps to minimize tearing at fastener point.



## Easy-to-Install

Product lays down flat and is easily repositionable.



## Trusted Quality and Durability

A product you can rely on from DuPont™, a leader in science-based building envelope materials.



# MOULDING & MILLWORK



Billings, MT



Ennis, MT



Billings, MT



Other species and profiles available upon request. Please inquire about our prefinishing and stocking dealer programs.



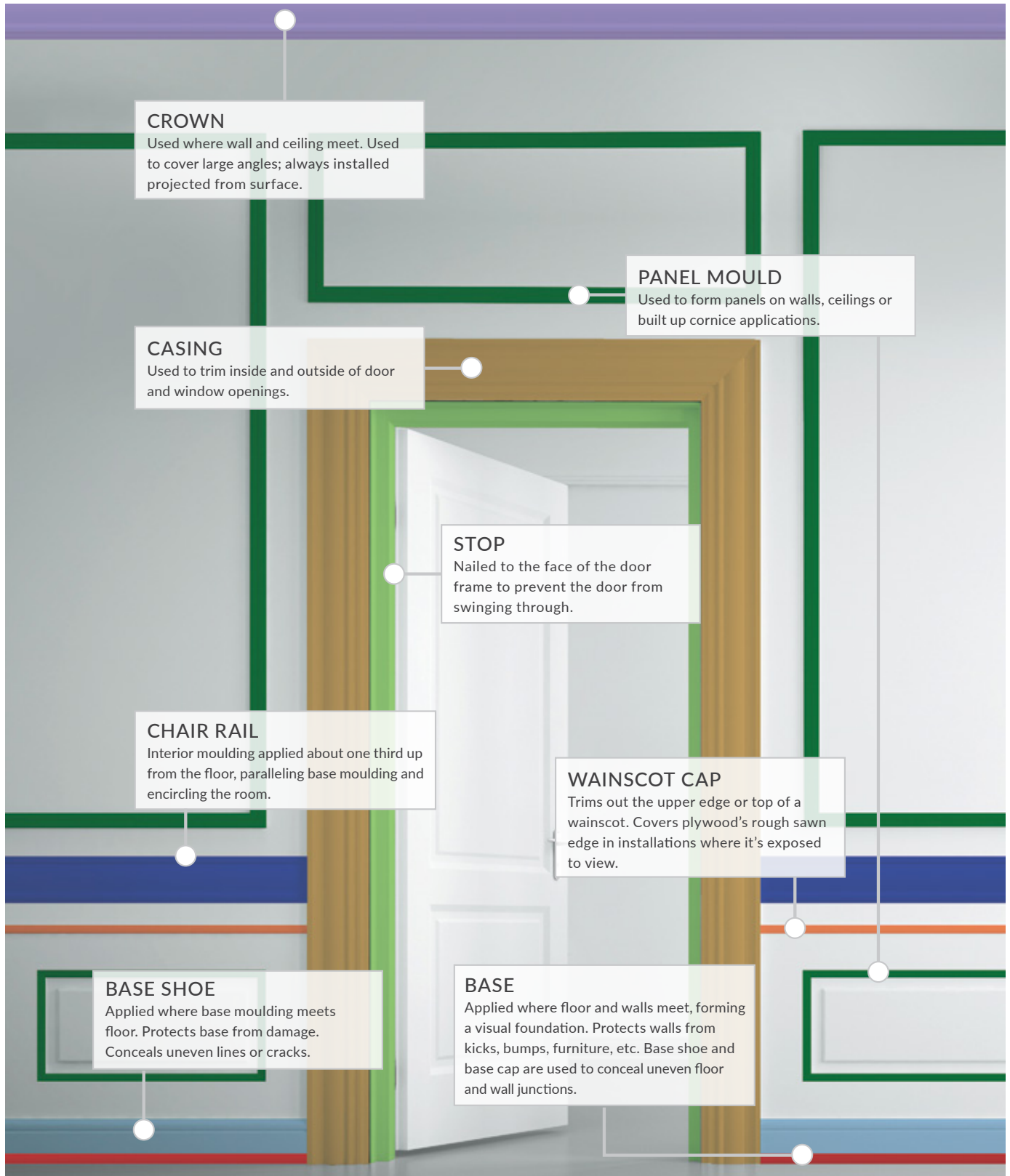

**CROWN**  
Used where wall and ceiling meet. Used to cover large angles; always installed projected from surface.

**PANEL MOULD**  
Used to form panels on walls, ceilings or built up cornice applications.

**CASING**  
Used to trim inside and outside of door and window openings.

**STOP**  
Nailed to the face of the door frame to prevent the door from swinging through.

**CHAIR RAIL**  
Interior moulding applied about one third up from the floor, paralleling base moulding and encircling the room.

**WAINSCOT CAP**  
Trims out the upper edge or top of a wainscot. Covers plywood's rough sawn edge in installations where it's exposed to view.

**BASE SHOE**  
Applied where base moulding meets floor. Protects base from damage. Conceals uneven lines or cracks.

**BASE**  
Applied where floor and walls meet, forming a visual foundation. Protects walls from kicks, bumps, furniture, etc. Base shoe and base cap are used to conceal uneven floor and wall junctions.

## Architrave

## Base Moulding

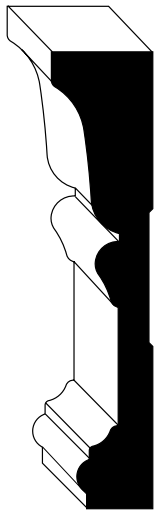

5020

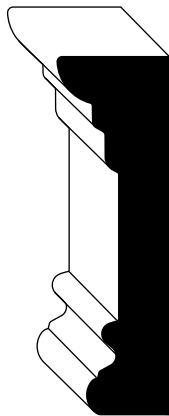

5475  
5000  
RB3

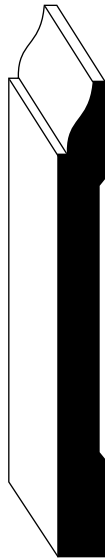

618



620



623

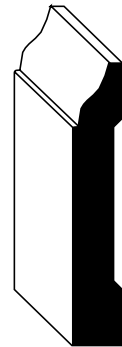

625  
634

Item	Profile	Pattern	Size	Material	Stock
5020	Architrave	-	1-3/16" x 5-1/4"	(M)	○
5475	Architrave	-	1-3/16" x 3-3/4"	(H)	○
5000	Architrave	-	1" x 4-3/4"	(KA)	○
RB3	Architrave	-	1-3/16" x 3-3/4"	(M)	○
618	Base	Moulded	1/2" x 5-1/4"	(H)	○
"	"	"	9/16" x 5-1/4"	(M)* (KA)	○
620	Base	Moulded	9/16" x 4-1/4"	(KA)	○
623	Base	Moulded	1/2" x 3-1/4"	(KA) (M)*	○
"	"	"	7/16" x 3-1/4"	(H)	○
"	"	"	9/16" x 3-1/4"	(FJP)*	○
625	Base	Moulded	7/16" x 2-1/4"	(H)*	○
634	Base	Moulded	1/2" x 2-1/2"	(M)*	○

\*Radius corner available.

## Base Moulding

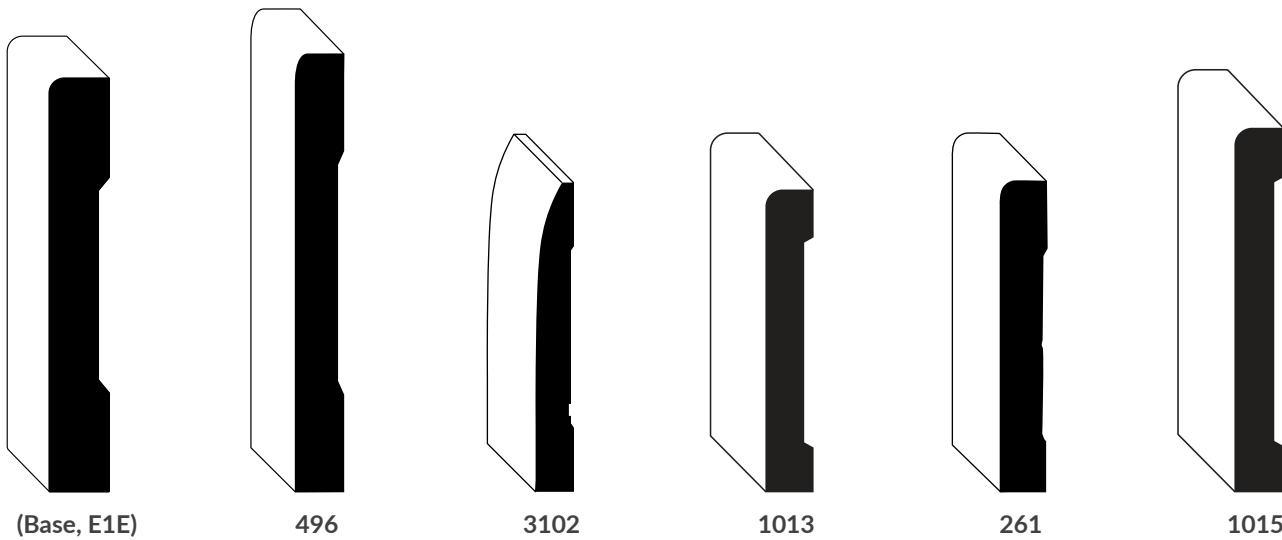

Item	Profile	Pattern	Size	Material	Stock
***	Base	E1E	5/8" x 5"	KA	●
496	Base	Bullnose	9/16" x 5-3/8"	H	○
3102	Base	Streamline	7/16" x 3-1/4"	H	○
1013	Base	E1E	1/2" x 3-1/4"	KA	○
261	Base	Bullnose	1/2" x 3-1/4"	M	○
1015	Base	E1E	1/2" x 5-1/4"	KA	○

KEY: **H** Hemlock **FJP** Fingerjoint Primed Pine **KA** Knotty Alder **M** MDF



Base Moulding

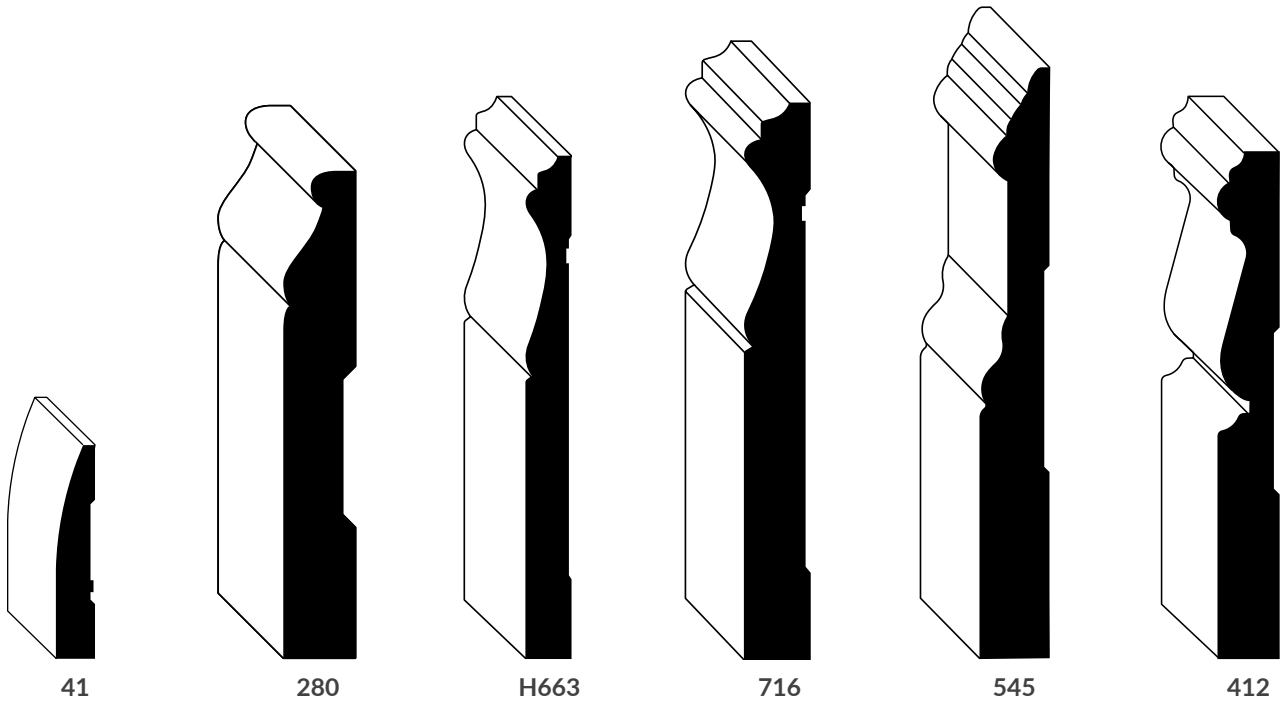

MOULDING & MILLWORK

Item	Profile	Pattern	Size	Material	Stock
41	Base	Streamline	7/16" x 2-1/4"	H	○
280	Base	-	5/8" x 5"	KA	●
H663	Base	Gingerbread	7/16" x 4-1/4"	H	○
716	Base	-	9/16" x 4-5/8"	FJP	○
545	Base	-	5/8" x 5"	M	○
412	Base	Cambridge	9/16" x 4-1/2"	M	○

## Base Moulding

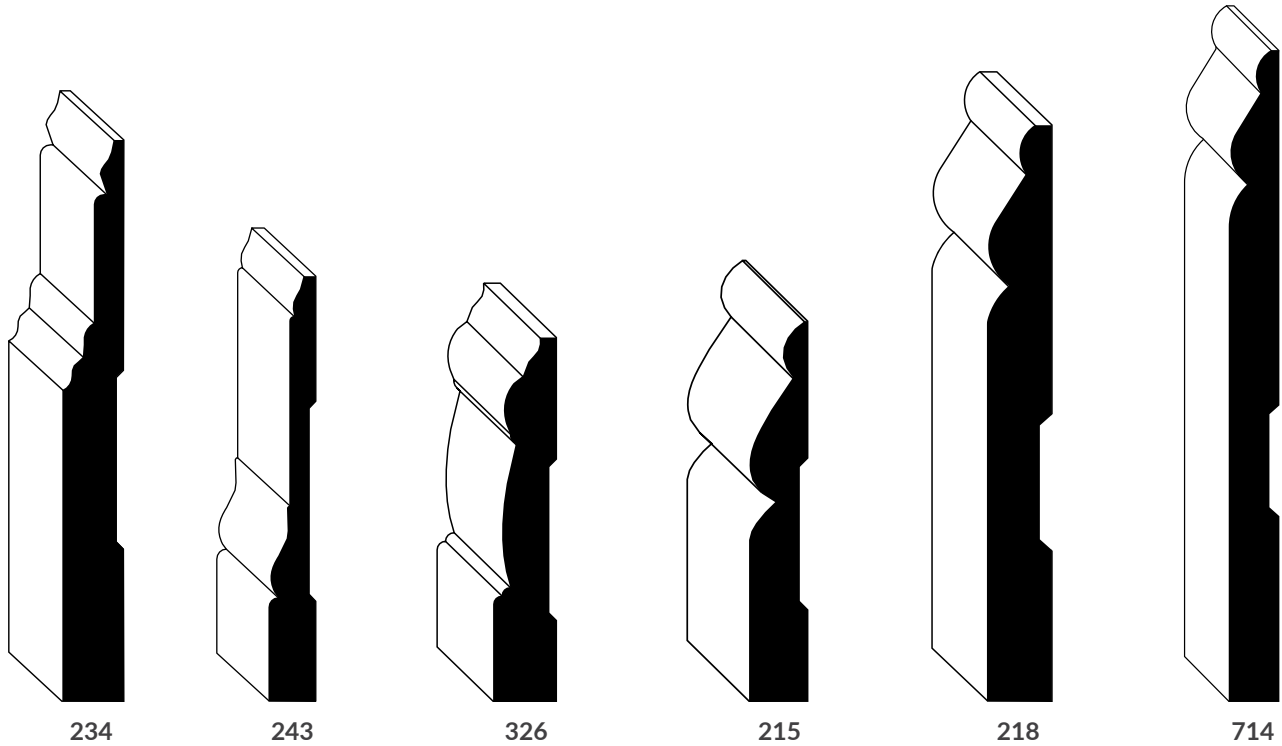

Item	Profile	Pattern	Size	Material	Stock
234	Base	-	9/16" x 5-1/2"	(M)	○
243	Base	-	1/2" x 4-1/4"	(M)	○
326	Base	-	9/16" x 3-3/8"	(M)	○
215	Base	Sierra	1/2" x 3-1/8"	(M)	○
218	Base	Sierra	9/16" x 5-1/4"	(M)*	○
714	Base	Sierra	9/16" x 7-1/4"	(M)*	○

KEY: (H) Hemlock (FJP) Fingerjoint Primed Pine (KA) Knotty Alder

\*Radius corner available.

● In-stock  
○ In-stock Regionally (Additional Lead-time)

## Casing

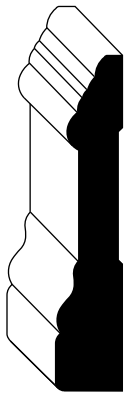

535

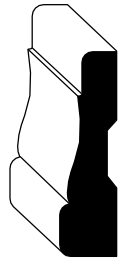

356

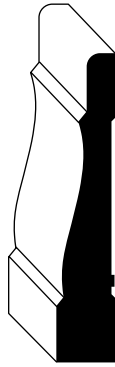

444

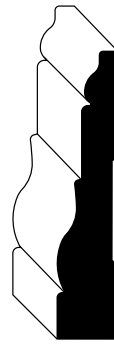

39



410



62

Item	Profile	Pattern	Size	Material	Stock
535	Casing	-	11/16" x 3-1/2"	(M)	○
"	"	"	3/4" x 3-1/2"	(H)	○
356	Casing	Colonial	9/16" x 2-1/2"	(M)*	○
"	"	"	5/8" x 2-1/4"	(H)* (FJP)*	○
444	Casing	Colonial	5/8" x 3-1/8"	(FJP) (M)	○
"	"	"	5/8" x 3-1/4"	(H)	○
"	"	"	5/8" x 3-1/4"	(KA)	●
39	Casing	-	11/16" x 3-1/4"	(KA)	○
410	Casing	-	11/16" x 2-1/4"	(M)	○
62	Casing	-	3/4" x 2-3/4"	(KA)	○

\*Radius corner available.



## Casing

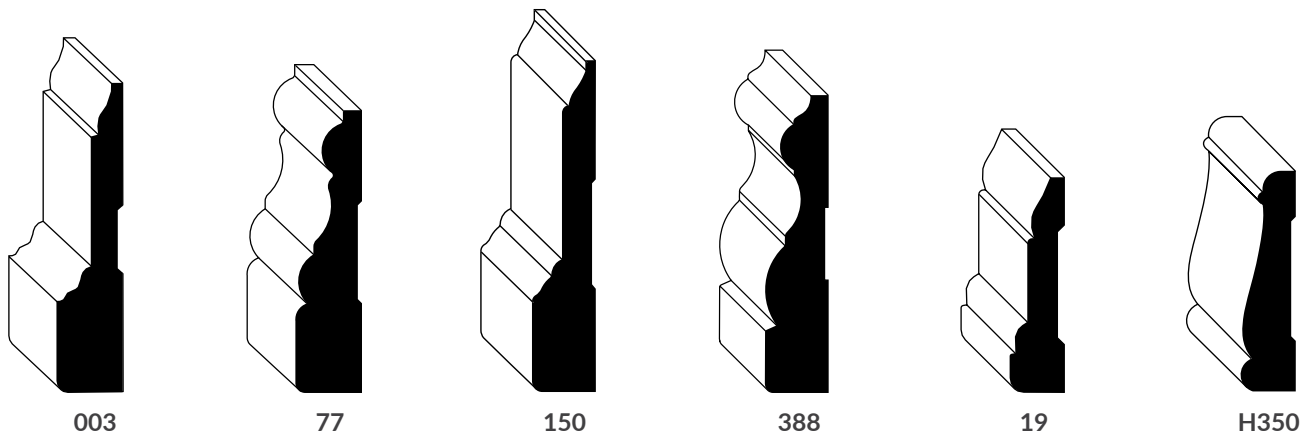

Item	Profile	Pattern	Size	Material	Stock
003	Casing	-	11/16" x 3-1/4"	(M)	○
72	Casing	-	11/16" x 3"	(M)	○
388	Casing	-	11/16" x 3-1/4"	(M)	○
19	Casing	Moulded	9/16" x 2-1/4"	(H) (M)	○
150	Casing	-	5/8" x 3-1/4"	(M)	○
H350	Casing	Beaded	9/16" x 2-1/4"	(H)	○

KEY: (H) Hemlock (FJP) Fingerjoint Primed Pine (KA) Knotty Alder (M) MDF

\*Radius corner available.

- In-stock
- In-stock Regionally (Additional Lead-time)

## Casing

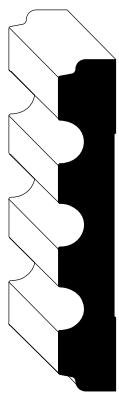

1003

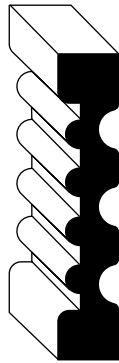

1001



908



1208



3005

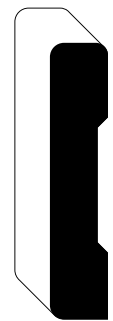

(Casing, E2E Bullnose)

Item	Profile	Pattern	Size	Material	Stock
1003	Casing	Fluted	5/8" x 3-3/8"	(M)	○
1001	Casing	Flute & Reed	5/8" x 3-1/4"	(H)	○
908	Casing	Reed	5/8" x 3-3/8"	(M)	○
1208	Casing	Beaded	11/16" x 2-1/2"	(H) (FJP)	○
3005	Casing	Beaded	1/2" x 1-1/2"	(H)	○
-	Casing	E2E Bullnose	5/8" x 3-1/2"	(KA)	●

## Casing

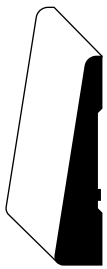

3002 / 214

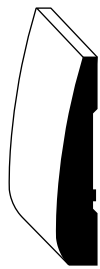

3014



H327



3000 / 158

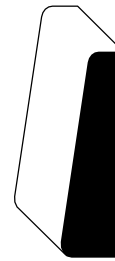

H324

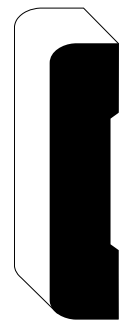

495

Item	Profile	Pattern	Size	Material	Stock
3002	Casing	Bevel	1/2" x 2-1/4"	<span style="background-color: #808080; border-radius: 50%; padding: 2px;">H</span>	<input type="radio"/>
"	"	"	9/16" x 2-1/4"	<span style="background-color: #8B4513; border-radius: 50%; padding: 2px;">FJP</span>	<input type="radio"/>
214	Casing	Bevel	9/16" x 2-1/4"	<span style="border: 1px solid black; border-radius: 50%; padding: 2px;">M</span>	<input type="radio"/>
3014	Casing	Streamline	7/16" x 2-1/4"	<span style="background-color: #808080; border-radius: 50%; padding: 2px;">H</span>	<input type="radio"/>
H327	Casing	Streamline	5/8" x 2-1/4"	<span style="background-color: #808080; border-radius: 50%; padding: 2px;">H</span>	<input type="radio"/>
3000	Casing	Bevel	1/2" x 1-1/2"	<span style="background-color: #808080; border-radius: 50%; padding: 2px;">H</span>	<input type="radio"/>
158	Casing	Bevel	9/16" x 1-9/16"	<span style="border: 1px solid black; border-radius: 50%; padding: 2px;">M</span>	<input type="radio"/>
H324	Casing	Bevel	11/16" x 2-1/4"	<span style="background-color: #808080; border-radius: 50%; padding: 2px;">H</span>	<input type="radio"/>
495	Casing	E2E Bullnose	3/4" x 3-1/2"	<span style="background-color: #3CB371; border-radius: 50%; padding: 2px;">KA</span>	<input type="radio"/>
"	"	"	5/8" x 3-1/4"	<span style="background-color: #808080; border-radius: 50%; padding: 2px;">H</span>	<input type="radio"/>
"	"	"	11/16" x 3-1/2"	<span style="border: 1px solid black; border-radius: 50%; padding: 2px;">M</span>	<input type="radio"/>

KEY: H Hemlock FJP Fingerjoint Primed Pine KA Knotty Alder M MDF



Casing

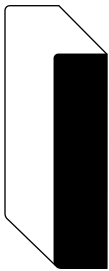

473

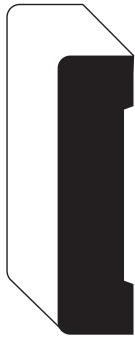

1002 / 1003

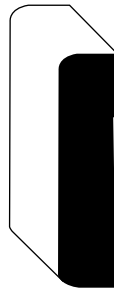

472



433

Item	Profile	Pattern	Size	Material	Stock
473	Casing	Bullnose	9/16" x 2-1/4"	(M)	○
1002	Casing	E2E Bullnose	5/8" x 2-1/4"	(KA)	○
1003	Casing	E2E Bullnose	5/8" x 3-1/4"	(KA)	○
472	Casing	VG E2E Bullnose	5/8" x 2-1/4"	(H)	○
433	Casing	E2E Bullnose	9/16" x 3-1/4"	(M)	○

\*Radius corner available.

## Crown

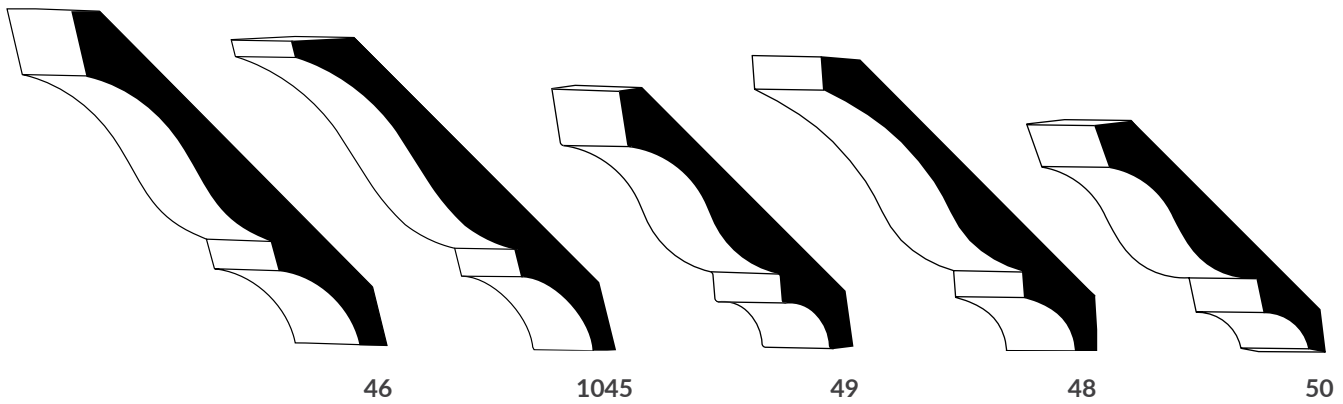

Item	Profile	Pattern	Size	Material	Stock
46	Crown	-	9/16" x 5-1/4"	(M)	○
1045	Crown	-	11/16" x 5-1/4"	(KA)	○
49	Crown	-	9/16" x 3-5/8"	(FJP) (M)	○
48	Crown	-	9/16" x 4-1/4"	(M)	○
50	Crown	-	1/2" x 3-7/16"	(H)	○
54	Crown	-	1/2" x 2-1/4"	(H)	○

KEY: (H) Hemlock (FJP) Fingerjoint Primed Pine (KA) Knotty Alder (M) MDF

**Crown**

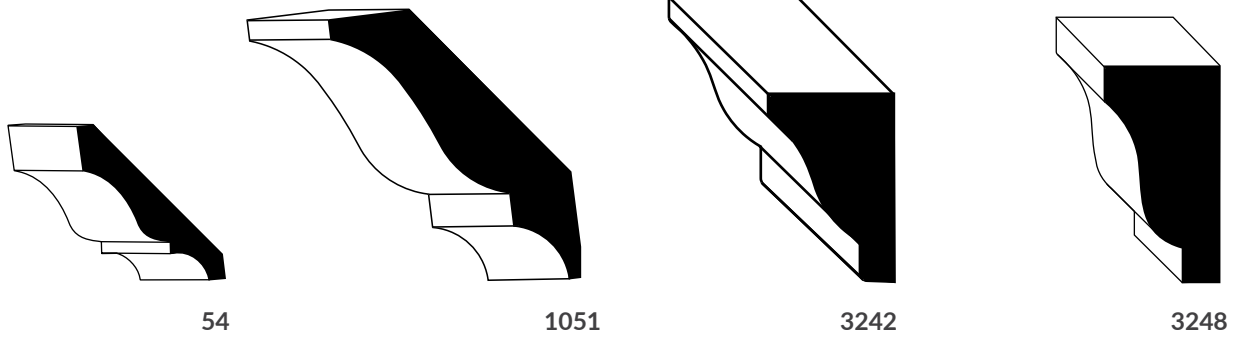

Item	Profile	Pattern	Size	Material	Stock
473	Casing	Bullnose	9/16" x 2-1/4"	(M)	○
1002	Casing	E2E Bullnose	5/8" x 2-1/4"	(KA)	○
1003	Casing	E2E Bullnose	5/8" x 3-1/4"	(KA)	○
472	Casing	VG E2E Bullnose	5/8" x 2-1/4"	(H)	○
433	Casing	E2E Bullnose	9/16" x 3-1/4"	(M)	○



## Door Header

## Chair Rail

## Wainscot Cap

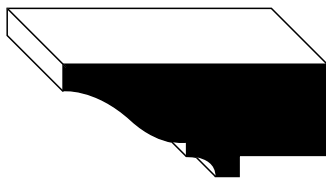

802



297



390



292

Item	Profile	Pattern	Size	Material	Stock
802	Door Header	-	1-1/16" x 2-1/4"	KA	○
297	Chair Rail	-	11/16" x 3"	M	○
390	Chair Rail	-	5/8" x 2-7/16"	H	○
"	"	"	11/16" x 2-5/8"	FJP	○
292	Wainscot Cap	-	9/16" x 1-1/8"	H	○

KEY: ● In-stock ○ In-stock Regionally (Additional Lead-time)  
 H Hemlock SP Solid Pine FJP Fingerjoint Primed Pine KA Knotty Alder M MDF

## Rounds, Half Rounds & Quarter Rounds



106, 3206,  
105, 111



3201



3212

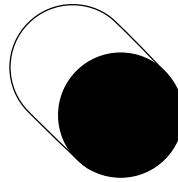

3226



3202



3200

Item	Profile	Pattern	Size	Material	Stock
106	Quarter Round	-	11/16" x 11/16"	FJP	○
3206	Quarter Round	-	11/16" x 11/16"	H	○
105	Quarter Round	-	3/4" x 3/4"	SA	○
111	Quarter Round	-	3/8" x 3/8"	SA	○
3201	Quarter Round	-	3/8" x 3/8"	H	○
3212	Half Round	-	3/4"	H	○
3226	Full Round	-	1-5/16"	H	○
3202	Quarter Round	-	1/2" x 1/2"	H	○
3200	Quarter Round	-	1/4" x 1/4"	H	○

## Square, Stop & Parting Strip

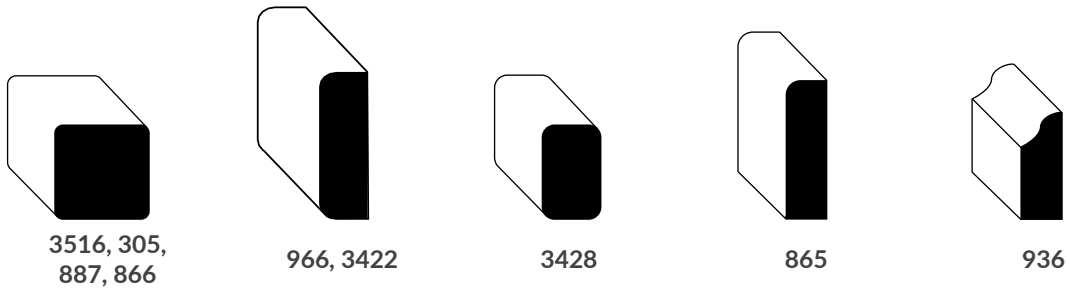

Item	Profile	Pattern	Size	Material	Stock
3516	Square	-	11/16" x 11/16"	<span>H</span>	<input type="radio"/>
305	Bullnose Stop	-	3/8" x 1-1/4"	<span>O</span>	<input type="radio"/>
887	Bullnose Stop	-	3/8" x 1-1/4"	<span>H</span> <span>FJP</span> <span>MG</span>	<input type="radio"/>
"	"	"	7/16" x 1-1/4"	<span>SP</span>	<input type="radio"/>
866	Bullnose Stop	-	7/16" x 1-5/16"	<span>H</span>	<input type="radio"/>
966	Stop	-	1/2" x 1-1/2"	<span>H</span> <span>FJP</span> <span>KA</span>	<input type="radio"/>
3422	-	-	5/16" x 1-3/16"	<span>H</span>	<input type="radio"/>
3428	Parting Strip	-	7/16" x 11/16"	<span>H</span>	<input type="radio"/>
865	Bullnosed	1-Edge	7/16" x 1-1/2"	<span>H</span>	<input type="radio"/>
936	Stop	Colonial	1/2" x 1-3/8"	<span>KA</span>	<input type="radio"/>
"	"	"	3/8" x 1-3/8"	<span>H</span>	<input type="radio"/>
"	"	"	7/16" x 1-3/8"	<span>FJP</span>	<input type="radio"/>

KEY: H Hemlock SP Solid Pine FJP Fingerjoint Primed Pine O Oak KA Knotty Alder SA Superior Alder MG Mahogany

● In-stock  
○ In-stock Regionally (Additional Lead-time)



## Brickmould

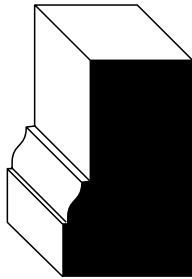

180

## Handrail

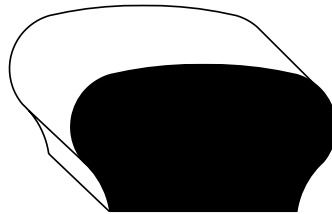

3507

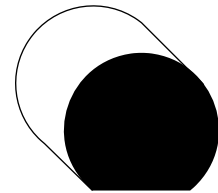

231

## Outside Corner

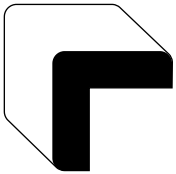

204

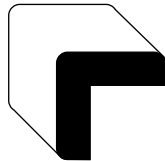

205

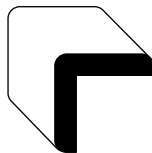

3280

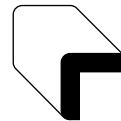

3282

Item	Profile	Pattern	Size	Material	Stock
180	Brickmould	-	1-1/4" x 2"	<span>H</span> <span>FJP</span> <span>KA</span>	<input type="radio"/>
3507	Hand Rail	Oval	1-1/4" x 2-1/4"	<span>H</span>	<input type="radio"/>
231	Hand Rail	Round	1-7/16" x 1-5/8"	<span>H</span>	<input type="radio"/>
204	Outside Corner	-	1-1/4" x 1-1/4"	<span>H</span>	<input type="radio"/>
205	Outside Corner	-	1-1/8" x 1-1/8"	<span>FJP</span>	<input type="radio"/>
3280	Outside Corner	-	1-1/16" x 1-1/16"	<span>H</span>	<input type="radio"/>
3282	Outside Corner	-	11/16" x 11/16"	<span>H</span>	<input type="radio"/>

KEY: H Hemlock FJP Fingerjoint Primed Pine KA Knotty Alder SA Superior Alder M MDF O Oak

## Lattice & Opening Trim

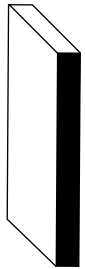

264



266

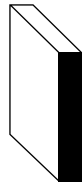

267



268

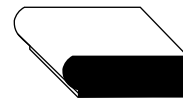

953

## Cove

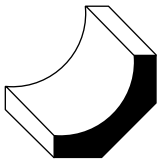

334

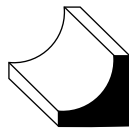

93

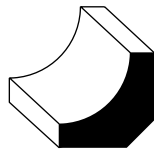

3260

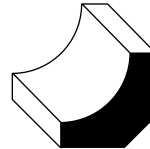

3264

Item	Profile	Pattern	Size	Material	Stock
264	Lattice	-	1/4" x 2-1/4"	H	○
266	Lattice	-	1/4" x 1-5/8"	H	○
267	Lattice	-	1/4" x 1-3/8"	H	○
268	Lattice	-	1/4" x 1-1/8"	H	○
953	Opening Trim	-	1/2" x 1-3/8"	SA	○
"	"	-	7/16" x 1-5/16"	H	○
"	"	"	7/16" x 1-3/8"	FJP (M)	○
334	Cove	-	1-1/2" x 1-1/2"	H	○
93	Cove	-	3/4" x 3/4"	FJP O	○
3260	Cove	-	1/2" x 1/2"	H	○
3264	Cove	-	11/16" x 11/16"	H	○

## Picture Mould, Base Shoe, Screen, Cant Strip

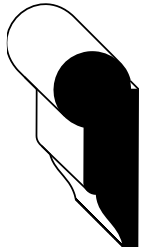

1010



H13

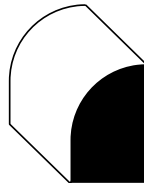

3288, 126



3274

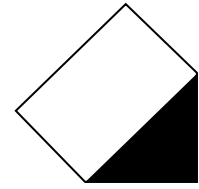

995

Item	Profile	Pattern	Size	Material	Stock
1010	Picture Mould	-	11/16" x 1-5/8"	H	<input type="radio"/>
H13	Fluted Screen	-	1/4" x 3/4"	H	<input type="radio"/>
3288	Base Shoe	-	7/16" x 11/16"	H	<input type="radio"/>
126	Base Shoe	-	1/2" x 3/4"	FJP	<input type="radio"/>
3274	Screen Flat	-	1/4" x 3/4"	H	<input type="radio"/>

## T&G, 90° Corner

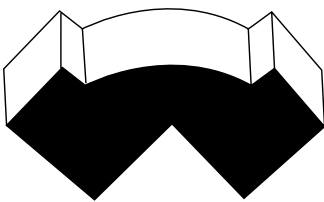

352



HBP5804

Item	Profile	Pattern	Size	Material	Stock
352	90 Degree Corner	-	1-7/16" x 3-1/8"	FJP	<input type="radio"/>
HBP5804	T&G mg	-	5/8" x 3-3/8"	H	<input type="radio"/>

KEY: **H** Hemlock **FJP** Fingerjoint Primed Pine

## Flat Stock MDF Ultralite and Knotty Alder Boards



E2E



Board Flat Stock

Item	Style	Nominal Size	Material	Stock
E2E	Eased 2 Edges	1" x 3"	(MU)	●
E2E	Eased 2 Edges	1" x 4"	(MU)	●
E2E	Eased 2 Edges	1" x 6"	(MU)	●
E2E	Eased 2 Edges	1" x 8"	(MU)	●
E2E	Eased 2 Edges	1" x 12"	(MU)	●
Board	Flat Stock	1" x 4"	(KA)	●
Board	Flat Stock	1" x 6"	(KA)	●
Board	Flat Stock	1" x 8"	(KA)	●
Board	Flat Stock	1" x 10"	(KA)	●
Board	Flat Stock	1" x 12"	(KA)	●
Board	Flat Stock	5/4" x 4"	(KA)	●
Board	Flat Stock	5/4" x 6"	(KA)	●

KEY: (KA) Knotty Alder (MU) MDF Ultralite

● In-stock  
○ In-stock Regionally (Additional Lead-time)



# MESSMER'S PRODUCT LINE



## U.V. Plus for Hardwood Decks

An oil-based product that protects and conditions woods such as Ipe and Mahogany, while also maintaining a natural appearance. It has been produced with professional results in mind, providing exceptional penetration, water repellency, and ultraviolet light protection.

### Coverage

Decking	200 - 250 sq ft/gal
---------	---------------------



## U.V.Plus

An oil-based penetrating wood finish suitable for decks, log homes, wood siding, fencing, and other exterior wood surfaces. U.V. Plus protects wood, while maintaining a natural appearance.

### Coverage

Smooth Wood	150 - 250 sq ft/gal
Rough Wood	100 - 150 sq ft/gal

## Wood & Deck 2-Part System

Wood & Deck Part-A removes dirt and grey from wood, and prepares weathered wood for treating with Messmer's U.V. Plus. Wood & Deck Part-B is used after cleaning with Part A to brighten the wood without bleaching and to restore wood's natural color.



## Wood & Deck Renewer

A scientifically-formulated product intended to give a new and restored appearance to weathered wood. It prepares the wood's surface and restores it to its original appearance without bleaching or damaging the wood. Wood & Deck Renewer and Brightener begins to work as soon as it contacts the surface. Get beautiful wood in one easy step.



### Coverage

200 - 300 sq ft/gal\*

\*Depending on wood porosity

Contact your Sales Rep today to find out about our spring dating program or becoming a stocking dealer!

# MESSMER'S PRODUCT LINE



## Timberflex

A premium oil base, film-forming exterior wood finish. Timberflex remains flexible and ultraviolet light resistant, even in extreme environments, and is excellent for log homes and many other vertical exterior wood surfaces.

### Coverage

---

#### Smooth Wood:

1<sup>st</sup> Coat 200 - 300 sq ft/gal  
2<sup>nd</sup> Coat 300 - 400 sq ft/gal  
3<sup>rd</sup> Coat 400 - 600 sq ft/gal

#### Rough Wood:

1<sup>st</sup> Coat 125 - 150 sq ft/gal  
2<sup>nd</sup> Coat 200 - 300 sq ft/gal  
3<sup>rd</sup> Coat 400 - 600 sq ft/gal



## Timberflex Exterior Stain

An oil-based product designed to seal and protect interior wood surfaces, while maintaining a natural appearance. Its quick dry, satin finish provides a washable clear coating for easy maintenance.

### Coverage

---

#### Rough Wood:

1<sup>st</sup> Coat 150 - 250 sq ft/gal  
2<sup>nd</sup> Coat 200 - 300 sq ft/gal

#### Smooth Wood:

1<sup>st</sup> Coat 200 - 300 sq ft/gal  
2<sup>nd</sup> Coat 300 - 400 sq ft/gal



### Also Available:

---

U.V. Plus for Pressure Treated  
Semi-Opaque Decking & Siding  
Timberflex Pro

Caribbean Extreme  
Composite Deck Finish  
Composite Deck Cleaner

Contact your Sales Rep today to find out about our spring dating program or becoming a stocking dealer!

# MESSMER'S FILM-FORMING FINISHES



A film-forming finish builds protective layers over the surface of the wood as multiple coats are applied. These layers provide a flexible finish that withstands severe climates, and prevents the penetration of water and ultraviolet light. The Timberflex line is considered "natural" because along with the protection the finish provides, it allows the grain and look of the wood to show through.



**U.V. Plus**

One coat of U.V. Plus Natural provides a look closest to the original wood, highlighting the grain and protecting the surface from ultraviolet light and moisture damage.



**Timberflex Gloss**

A three coat system, two coats of Timberflex Natural and one coat of Timberflex Gloss provides a high-gloss wood finish.



**Timberflex Satin**

A three coat system, two coats of Timberflex Natural and one coat of Timberflex Satin results in a smooth, satin finish for exterior wood.



**Timberflex II Natural**

Three coats of waterborne Timberflex II Natural give the wood an even sheen and provides excellent color retention, without sacrificing performance or beauty.

## The Messmer's Finish Coat Process:

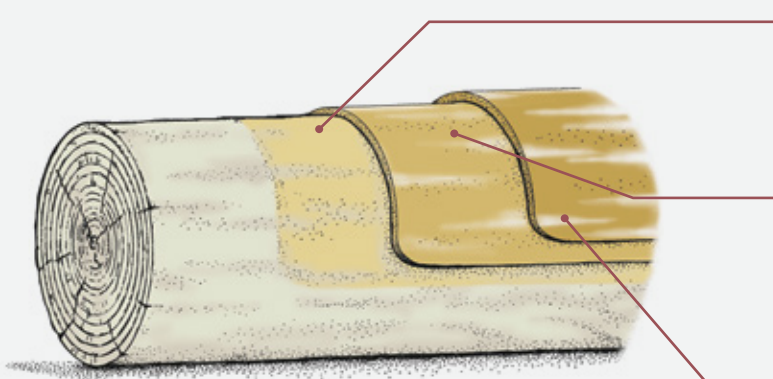

The first coat, a color coat, is absorbed into the surface of the wood and fills the pores with protective oils, resins, and ultraviolet light absorbers.

The second coat, another color coat using the same product as the first coat, builds the first layer of the film, increasing the protection against sun, rain, and harmful weathering.

The third and last coat builds the film to a greater thickness. This coat gives the wood its finished look and added protection. It can be either another color coat, clear gloss or clear satin coat.

## #2/Btr Kiln-Dried PPLP S4S

8' to 16' Lengths. Eased Edge. HT Stamped.

1" x 4", 8'-16' lengths	1" x 10", 8'-16' lengths
1" x 6", 8'-16' lengths	1" x 12", 8'-16' lengths
1" x 8", 8'-16' lengths	

## C/Btr Kiln-Dried Radiata Pine S4S

1" x 2", 8' only	1" x 6", lengths 6'-16'
1" x 3", 8' only	1" x 8", lengths 6'-16'
1" x 4", lengths 6'-16'	1" x 12", lengths 6'-16'

## #3 Kiln-Dried PPLP S4S

8' to 16' Lengths. Eased Edge. HT Stamped.

1" x 4", 8'-16' lengths	1" x 10", 14' only
1" x 6", 8'-16' lengths	1" x 12", 16' only
1" x 8", 8'-16' lengths	

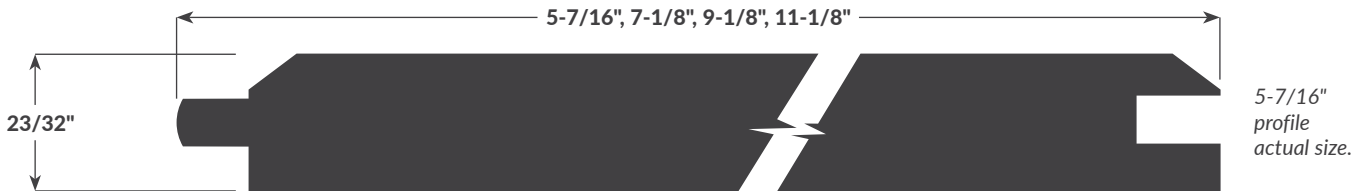

## Pattern Pine

1" x 6"	R/L #2/Btr	PPLP	WP4/Sq. Back/Fine Line
1" x 8"	R/L #2/Btr	PPLP	WP4/Sq. Back/Fine Line
1" x 6"	R/L #3/Btr	PPLP	WP4/Sq. Back
1" x 6"	#3/Btr	Blue Stain Pine	WP4/Sq. Back



## Premium ESLP K.D. Pine Furring Strips

Our 100% wane-free home center stock

2" x 2"	8'	450 pc/unit
1" x 2"	8'	900 pc/unit



# BOARD PATTERNS



**1 x 6 Prefinished #2 T&G Pine**

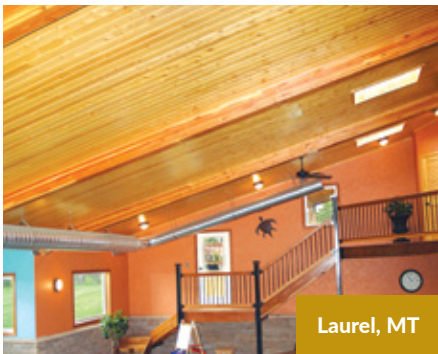

PINE



**T&G #3  
WP4/Sq. Back**

1" x 6"



**T&G #2 WP4/Sq.  
Back/Fine Line**

1" x 6"

1" x 8"



**T&G #3/Btr  
WP4/Sq. Back**

1" x 6" Blue Stain

*Custom prefinishing available upon request.*

# BOARD PATTERNS



## Siding & Decking Profiles

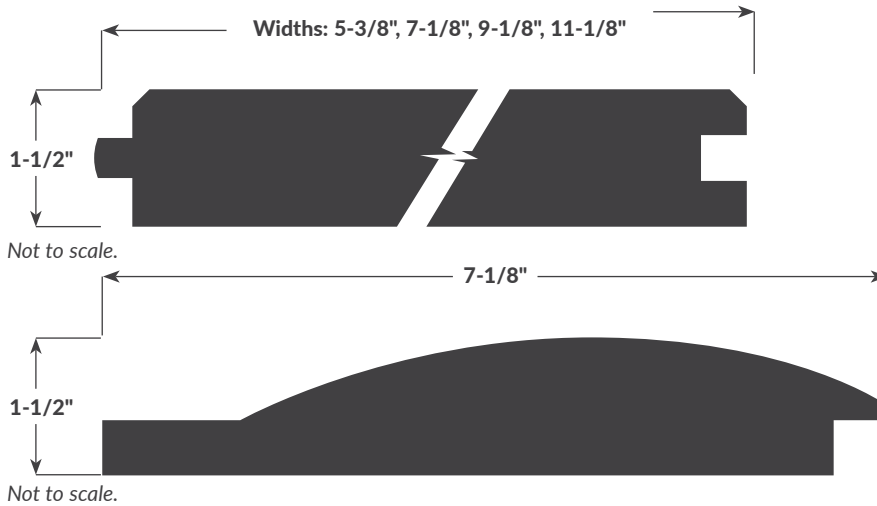

## Conversion Factors

2" x 6" T&G	<b>2.40</b>
2" x 8" Log Cabin	<b>2.28</b>

Sq. Ft. x Conversion Factor = Bd. Ft.

## #2/Btr Kiln-Dried ESLP

2" x 6"	T&G Decking	EV1S		
2" x 8"	Log Cabin Siding	S/L Edge	Smooth Face	Round-to-Round
2" x 8"	Log Cabin Siding	S/L Edge	Smooth Face	3/4" Gap Pattern
2" x 8"	Log Cabin Siding	S/L Edge	Hand Hewn	Round-to-Round
3" x 10"	Log Cabin Siding	S/L Edge	Hand Hewn	Round-to-Round

Random Lengths 8'-16'



**Log Cabin Siding**

Log-to-Log



**Hand-hewn Log Cabin Siding**

Log-to-Log Hand-hewn

Custom prefinishing available upon request.

# INSTALLATION & FINISHING



## Method of Drying

Lumber may be air-dried or kiln-dried. These terms do not necessarily refer to a specific moisture content but refer instead to the method used for drying. Air-dried lumber has been seasoned by exposure to the atmosphere, without artificial heat. Kiln-dried lumber has been seasoned in a chamber with the use of artificial heat. To assure compliance with a moisture content level, a moisture percentage should always be referenced.

## Siding Storage

All siding may pick up or lose moisture in transit or storage, so it is important to allow it to acclimate with the surrounding air of its final site prior to installation.

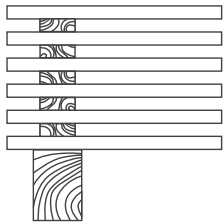

Stack the siding on evenly spaced, vertically-aligned stickers (spacers between the layers) in an area where there will be good air flow through the stack. This should be done in an open garage or other area that is protected from the elements.

If stacked over concrete, use 2x4's or 2x6's on edge to elevate the first course of siding at least 3.5 inches above the surface of the concrete. If the stack is over wet ground or wet concrete, lay down a vapor barrier so the wood doesn't pick up moisture from beneath the stack.

Allow air to flow through and around the stack for a 7 to 10 days for dry siding, prior to installation. Extend the time period to 30 days or longer for unseasoned siding or if acclimating in exceptionally humid conditions.

Further precautions must be taken if unseasoned or green materials, with a moisture content of more than 19%, are to be used successfully:

- 1.) Allow materials to acclimate, as described, over a longer period - at least 30 days and longer in damp or humid conditions - before installation.
- 2.) Use patterns which allow for some shrinkage, such as bevel, channel or board-and-batten. These patterns have a profile that includes a gap that can more easily accommodate dimensional change.
- 3.) Use as narrow a width as possible. Dimensional change is proportional; the wider the width, the greater the change.

## Priming and Prefinishing

Often, material which has been properly seasoned, stored, and handled will pick up moisture after installation, but prior to finishing. Later, when the siding loses that moisture, joints may open up.

Research from the U.S. Forest Products Lab indicates that siding exposed to the elements for two weeks weathers enough to reduce the adhesion of film-forming finishes.

Priming or prefinishing the siding (all sides, edges, and cut ends) after it has reached climatic balance, but before it is installed, can provide extra protection and often prevent adhesion problems and/or premature finish failure.

Back-priming the siding eliminates the leaching of chemical extracts, which have the potential to degrade sheathing wraps.

Prefinishing is recommended in all circumstances. Prefinishing will minimize objectionable unfinished lines where joints open up due to face-width shrinkage during exceptionally dry summers.

Make certain the prefinish is compatible with the final coat. For example, clear water repellents should not be used if a bleaching oil is to be the final finish.

# INSTALLATION & FINISHING



## Installation

Natural wood siding should be installed over a weather-resistive barrier regardless of the sheathing material. A weather-resistive barrier is a vapor-permeable sheathing wrap that resists any liquid water that gets behind the siding, and acts as a drainage plane.

There are three basic types of sheathing wrap: asphalt felt, grade D building paper, and plastic house wrap.

In order to function as a drainage plane, a sheathing wrap should have an air gap between the wrap and the siding. When sheathing material or sheathing wrap surfaces become wet, allow surfaces to dry before the wood siding is nailed into position.

Many patterns may be installed horizontally or vertically. Pattern orientation should restrict the entrance of moisture and weather. Some patterns, such as board-and-batten, may be installed only in a vertical fashion. Others, such as bungalow, bevel and drop, may be installed only horizontally.

Use caulk where siding abuts openings or trim. Latex-silicone blends, polyurethane, and polysulfide caulks should give satisfactory performance. 100% silicone caulks are not recommended.

Theoretically, any pattern which can be installed in either direction, such as channel or tongue-and-groove, can also be installed diagonally. However, diagonal installation tends to channel water directly into door jams, window casings or other joinery details on a structure.

If siding is to be installed diagonally, the project must be designed from the outset to accommodate the direction of run-off.

When wood siding is installed over metal studs, concrete or masonry, provide 2x nailers of sufficient spacing and size to meet the nailing requirements. This procedure is sometimes used when wood siding is installed over foam sheathing.

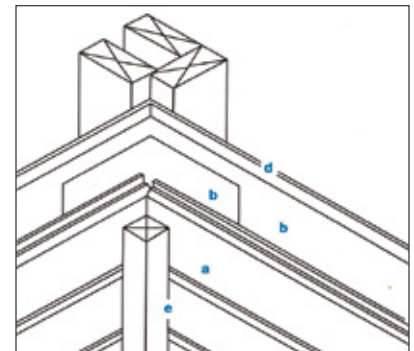
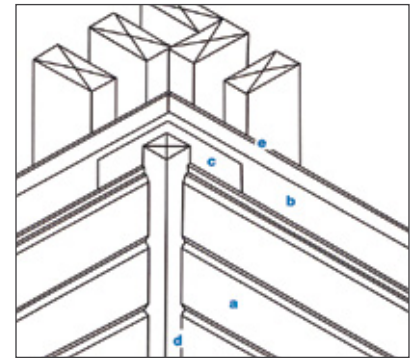
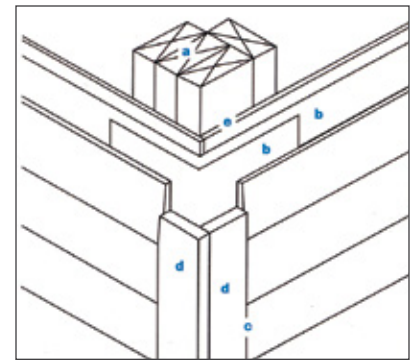
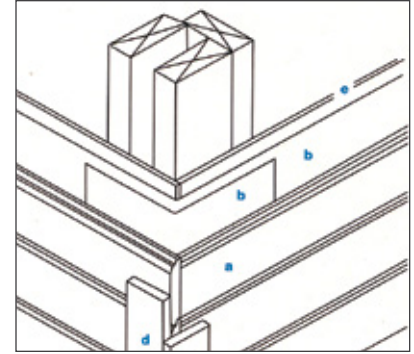

- a. HORIZONTAL SIDING
- b. BUILDING PAPER
- c. METAL FLASHING OR BUILDING PAPER
- d. USE CAULK AT INSIDE CORNER OR OPEN JOINT. PROVIDE METAL FLASHING BEHIND JOINT IF CAULK IS NOT USED.
- e. SHEATHING



# INSTALLATION & FINISHING



## Siding Pattern

## Nominal Sizes

## Nailing Recommendation



### Trim Board-on-Board and Board-on-Batten

Boards are surfaced smooth, rough or saw-textured. Rustic ranch-style appearance. Provide horizontal nailing members. Do not nail.

- 1" x 2"
- 1" x 4"
- 1" x 6"
- 1" x 10"
- 1" x 12"
- 1-1/4" x 6"
- 1-1/4" x 8"
- 1-1/4" x 10"
- 1-1/4" x 12"

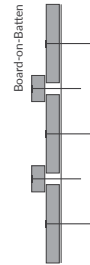

6" and narrower: Recommend 1/2" overlap. One siding or box nail per bearing.

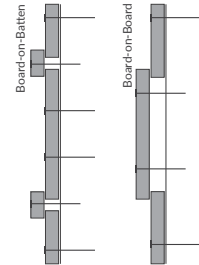

8" and wider: Increase overlap proportionately. Use two siding or box nails, 3-4" apart.



### Drop

Drop siding is available in 13 patterns, in smooth, rough or saw-textured surfaces. Some are T&G, others shiplap. A variety of looks can be achieved with the different patterns. Do not nail through overlapping pieces. Horizontal or vertical applications. Tongued edge up in horizontal applications.

- 3/4" x 6"
- 3/4" x 8"
- 3/4" x 10"

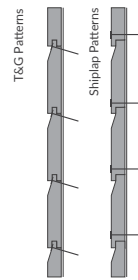

6" and narrower: Use casing nails to blind nail T&G patterns, one nail per bearing. Use siding or box nails to face nail shiplap patterns, 1" up from bottom edge.

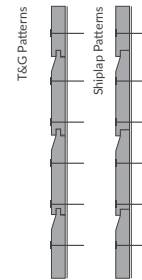

8" and wider: Use two siding or box nails, 3-4" apart to face nail, 1" up from bottom edge.

### Log Cabin

Log Cabin siding is 1-1/2" thick at the thickest point. Ideally suited to informal buildings in rustic settings. The pattern may be milled from appearance grades (commons) or dimension grades (2x material). Allow for 1/2" overlap, including an approximate 1/8" gap. Do not nail through overlapping pieces. Horizontal or vertical applications.

- 1-1/2" x 6"
- 1-1/2" x 8"
- 1-1/2" x 10"
- 1-1/2" x 12"



6" and narrower: Use one siding or box nail to face nail once per bearing, 1-1/2" up from the bottom edge.



8" and wider: Use two siding or box nails, 3-4" apart, per bearing to face nail.



## Siding Installation Tips

- Do not nail through overlapping pieces. Use stainless steel, high tensile strength aluminum, or hot-dipped galvanized nails with ring or spiral-threaded shanks. Use casing nails to blind nail; siding or box nails to face nail.
- Horizontal application only for Bevel, Bungalow, and Dolly Varden.
- Vertical applications only for Board-on-Board or Board-and-Batten; bevel cut ends of pieces and install so water is directed to outside.
- Horizontal or vertical applications for Tongue & Grooved, Channel Rustic, Log Cabin or Drop patterns. Tongue edge up in horizontal applications of Drop and T&G patterns.
- Read the section on *Nail Penetration and Spacing* to determine nail size
- Read the section on *Moisture Content and Prefinishing* before installing siding.



### Log Cabin Siding

1-1/2" x 10"

# SIDING INSTALLATION



Billings, MT

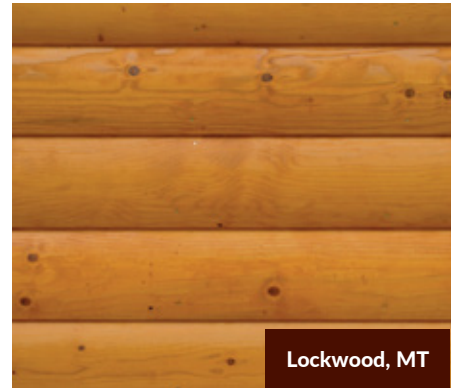

Lockwood, MT

## Nails and Nailing

Correct nails and nailing practices are essential in the proper application of wood siding. In general, siding and box nails are used for face nailing, and casing nails are used for blind nailing.

## Recommended Nails

Nails must be corrosion-resistant, and preferably rust-proof. Avoid using staples.

1. **Stainless Steel.** The best choice.

2. **High Tensile Strength Aluminum.**

An economical choice. This nail is corrosion-resistant and will not discolor or cause deterioration of the wood siding. However, aluminum nails will react with galvanized metal causing corrosion. **Do not use aluminum nails on galvanized flashing (nor galvanized nails on aluminum flashing).**

3. **Hot-Dipped Galvanized.**

This nail is least expensive, but may result in discoloration if precautions are not taken.

a. Make certain the nails are of top quality, as the degree of protective coating varies with the hot-dip galvanization process.

b. In some instances, the use of hot-dipped galvanized nails along with clear finishes on Western Red Cedar has resulted in stains around the nails. While this occurrence seems to be limited to the northeastern and north central regions of the country, **the combination of hot-dipped galvanized nails with clear finishes on Western Red Cedar is not recommended.**

c. Plastic hammer-head covers can be used when driving hot-dipped galvanized nails. This will reduce the potential for chipping and the subsequent potential for corrosion.

4. **Other Fasteners.** Other types of corrosion-resistant fasteners may perform satisfactorily. Before selecting an alternative fastener, check with the fastener manufacturer to determine whether or not it is suitable with the species of wood used for the siding. Avoid fasteners that may result in stains. Do not use staples or electroplated nails. These fasteners often result in black iron stains which can be permanent.

Copper nails are not suitable for Western Red Cedar as cedar's natural extracts will react with the copper, causing the nails to

corrode and resulting in stains on the siding.

While budgets are always a consideration, high-quality nails for solid wood siding are a wise investment. The discoloration, streaking or staining that can occur with inappropriate nails ruins the appearance of the project and can be very difficult to remove.

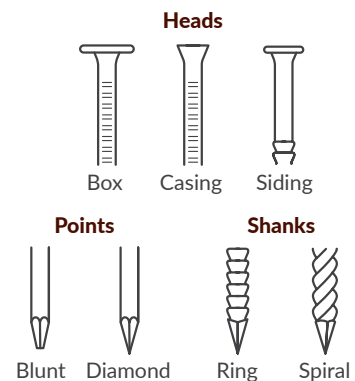

## Nail Shanks

Many nails have smooth shanks and will loosen as the siding expands and contracts under the extremes of seasonal changes in temperature and humidity. Ring or spiral-threaded nail shanks will increase the holding power. Both types of shanks are readily available.

# SIDING INSTALLATION



Roberts, MT



Lockwood, MT

## Nail Penetration and Spacing

Recommended penetration into studs or blocking, or into a combination of wood sheathing and these members, is 1-1/2". Penetration is 1-1/4" with ring shank nails.

Vertical siding, when applied over wood-based sheathing, should be nailed to horizontal blocking or other wood framing members not exceeding 36" on center when face-nailed, or 32" on center when blind-nailed. Vertical siding, when installed without sheathing, should be nailed to wood framing or blocking members at 24" on center. Some building codes require 24" on center, with or without sheathing; check your local code to verify requirements. Cut bevel (scarf) joints for vertical installations.

Horizontal and diagonal siding should be nailed to studs at 24" on center maximum when applied over wood-based, solid sheathing and 16" on center maximum when applied without sheathing.

The siding pattern will determine the exact nail size, placement and number of nails required.

Nails are placed to allow the wood to move, that is to shrink and swell, as well as to adequately hold the siding in place.

As a general rule, each piece of siding is nailed independently of its neighboring pieces. Do not nail through two overlapping pieces of siding with the same nail as this practice will restrict the natural movement of the siding and may cause unnecessary problems. Nail joints into the studs or blocking members.

Drive nails carefully. Hand nailing is preferred over pneumatic nailing because there is less control of placement and driving force with pneumatic nailers. Nails should be snug, but not overdriven. Nails that are overdriven can distort the wood and may cause excessive splitting.

Overdriven nails also provide an avenue for moisture to collect and move through the piece. Predrilling near the ends will help reduce any splitting that can occur with thinner patterns.

## Finishing

Natural wood siding can be finished with a variety of products to achieve just about any look desired. Finishes not only enhance the appearance of the wood, but also protect the siding against the detrimental effects of water, mildew, and ultraviolet light.

Among the wide range of exterior finishing products available, most finishes fall into four general categories: clear water repellents, bleaching oils, stains, and paints.

When choosing a particular finish, consider the desired appearance, preparation and maintenance requirements of the finish, location of the structure and current condition of the siding.

Some people prefer to leave natural wood siding unfinished, in hopes for a weathered appearance. This is not recommended. Siding without a finish can weather unevenly and is prone to surface mold, ultraviolet degradation, and moisture-related problems such as cupping and splitting. With the correct type of finish, a natural weathered look can be achieved, while providing protection for the siding to promote optimum performance over the years.



# SIDING INSTALLATION

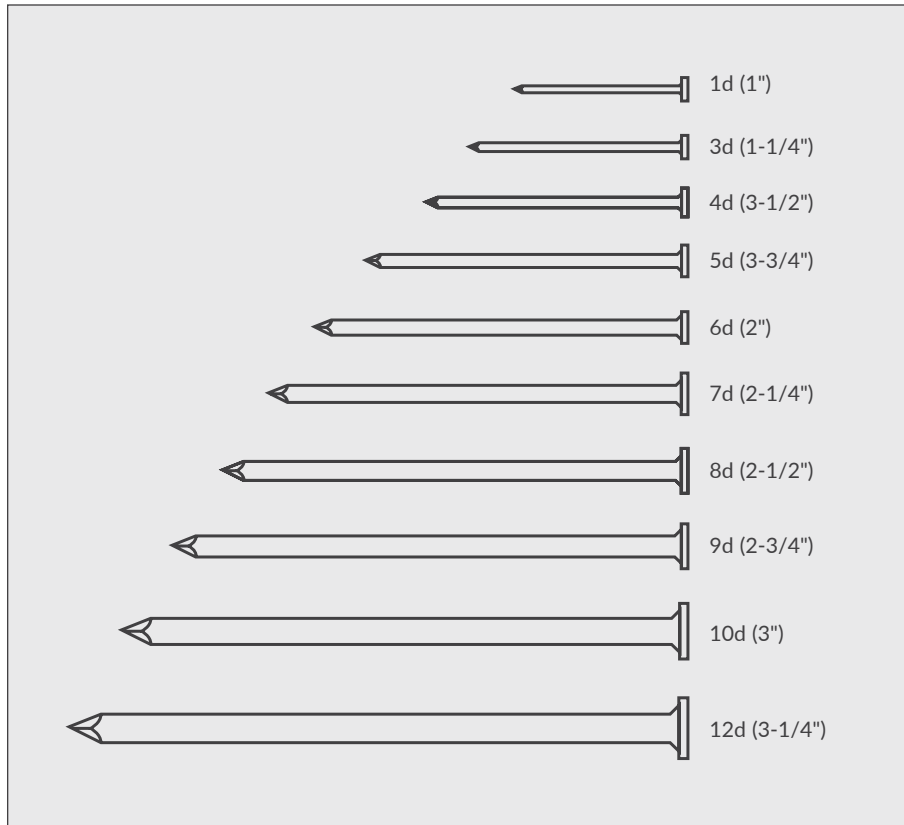

## Clear Water Repellents

Clear water repellents are one way to achieve a natural look. These products do not add color to the siding, and the natural colors and grain patterns can be seen through the finish. These repellents are often used on cedar siding when a weathered, silvery-grey color is desired.

Clear water repellents will not maintain the brand new look of siding because they do not prevent the sun's ultraviolet rays from fading the wood. Instead, water repellents allow the wood to fade naturally according to the amount of exposure the wood receives. However, some water repellents do contain ultraviolet inhibitors or ultraviolet blockers that help minimize the effects of the sun.

Always choose a water repellent that is formulated for wood, and contains a mildewcide to help prevent discoloration caused by mildew.

Water repellents are sometimes formulated with a preservative, such as zinc or naphthanate, that offers additional protection against decay. These are particularly useful in areas where the siding is constantly subjected to high moisture.

(Note: Some copper-based preservatives, such as copper naphthanate, may not be desirable because they have a green tint.)

When paint is to be the final finish, paintable clear water-repellent preservatives can also be applied prior to the prime coat to increase the service life of the top coats. Clear water repellents can be

expected to last from six months to two years, depending on the surface texture of the siding and the location and exposure of the structure.

Note: Clear water repellents should not be used under a bleaching oil finish.

## Bleaching Oils and Bleaching Stains

Bleaching oils and bleaching stains, sometimes called weathering stains, are another way to achieve a grey weathered look. However, the effect happens faster and the protection offered is longer-lived than with a clear water repellent.

# SIDING INSTALLATION



Meeteetse, WY



Roundup, MT



Château, MT

Bleaching products are similar to semi-transparent stains, but contain an added ingredient which causes the wood to bleach to a silver color within approximately six to twelve months. They are typically used on cedar siding.

Because of the pigmentation included in the formulation, bleaching oils and stains will color the wood grey upon application. Then, as the siding is exposed to sun and water, the bleaching oils begin to bleach the wood itself, resulting in a more uniform weathered look than can be achieved naturally.

Bleaching oils bring about a silvery-grey appearance that can last for many years; however, the protection offered by the oils may only last two

or three years. Consequently, it is a good idea to periodically apply a clear water repellent to the siding, over the bleaching oil, to protect it but not alter the color. If siding color becomes uneven over time, simply reapply another coat of bleaching oil.

## Stains

Stains are pigmented finishes that provide color and protection against ultraviolet rays. Many are also water repellents and may include mildewcides and preservatives as well.

Stains are classified as semi-transparent and opaque.

Semi-transparent stains have a moderate amount of pigment,

provide a fairly uniform color without hiding the wood grain. Oil-based, semi-transparent stains are recommended as they penetrate the wood surface more than water-based products.

As semi-transparent stains do not form a film, they are not subject to peeling or blistering, but do wear off gradually.

Semi-transparent stains can be expected to last from two to five years, depending on the surface texture of the wood, the exposure conditions, and the number of previous applications. For first-time applications on saw-textured siding, semi-transparent stains may last two years. Subsequent applications may last up to five years.

# SIDING INSTALLATION



Semi-transparent stains do not last as long on smooth sidings.

Opaque (solid or heavy-body) stains, have more pigment than semitransparent stains. Think of them as thin paints. Wood grain and color are not visible through opaque stains, but surface texture (roughness) is.

Opaque stains are available in oil or water-based formulations; however, oil-based formulations are recommended for cedar siding. Opaque stains may form a thin film on the wood surface and some can be subject to flaking. Opaque stains are not recommended over smooth siding unless a compatible primer is used prior to staining.

Service life is typically 3 to 7 years, depending on the surface texture, exposure of the building and number of previous applications.

## Primers and Paint

A paint system, properly applied, will provide more protection and last longer than other finishes. Paints are film-forming finishes that resist moisture absorption and block

ultraviolet rays. The variety of colors makes paint a popular finish; lighter colors are recommended over darker colors.

If good performance is to be expected, primers must be used. Primers are generally oil or water-based. Acrylic latex (water-based) primers are recommended for most wood species.

However, for woods naturally high in extractive content, such as Western Red Cedar, stain-blocking (oil-based or latex) primers must be used to help minimize discolorations that can occur when water interacts with the natural extracts, causing them to bleed through the surface of the primer. The primer must prevent the natural extracts in the wood from interacting with the water in subsequent finish coats.

Paints are formulated using either an oil (or alkyd) base or water base. Oil-based paints are generally more effective at blocking moisture than acrylic latex paints.

However, oil-based paints tend to form a more rigid film that can crack or blister if the wood moves

excessively as a result of changes in humidity. Acrylic latex paints are more flexible and will consequently shrink and expand with the wood, making them less prone to cracking. The recommended application for most species is one brush coat of acrylic latex primer followed by two coats of 100% acrylic latex paint. For species high in extracts such as cedar, use an oil-based primer or stain-blocking latex primer, then two coats of acrylic latex paint.

Note: A top-notch paint system includes prefinishing with one coat (or dip) of a paint-compatible water-repellent preservative. Refer to the section on prefinishing. This paint system can last up to 10 years.

## Checklist for High Performance, Long-Lasting, Beautiful Natural Wood Siding

- Select climate and design appropriate patterns with surface textures appropriate for desired finish.
- Specify species and grade compatible with budget.
- Allow siding to acclimate at job site.
- Prefinish all surfaces (sides, edges, ends) with:
  - » Water repellent that contains a mildewcide and is compatible with the final finish
  - » Stain or bleaching oil, if one of these is to be the final finish, or
  - » Primer, if paint is to be the final finish.
- Use an appropriate sheathing wrap. Make certain it is dry before applying siding.
- Allow for drainage between the sheathing wrap and the siding.
- Apply siding, using the right nails, in accordance with correct nailing procedures. Incorporate appropriate construction practices at corners.
- Provide additional coats of protective finish as required.



# DECKING



Red Lodge, MT



Driggs, ID

## IPE Decking

1" x 6"	Random Lengths	Air-dried
1" x 6"	Random Lengths	Kiln-dried

## Premium Radius Edge Decking

5/4" x 4"	R/L S4S	6' and longer
5/4" x 6"	R/L S4S	6' and longer



Dark Red, Kerfed

Custom prefinishing available upon request.

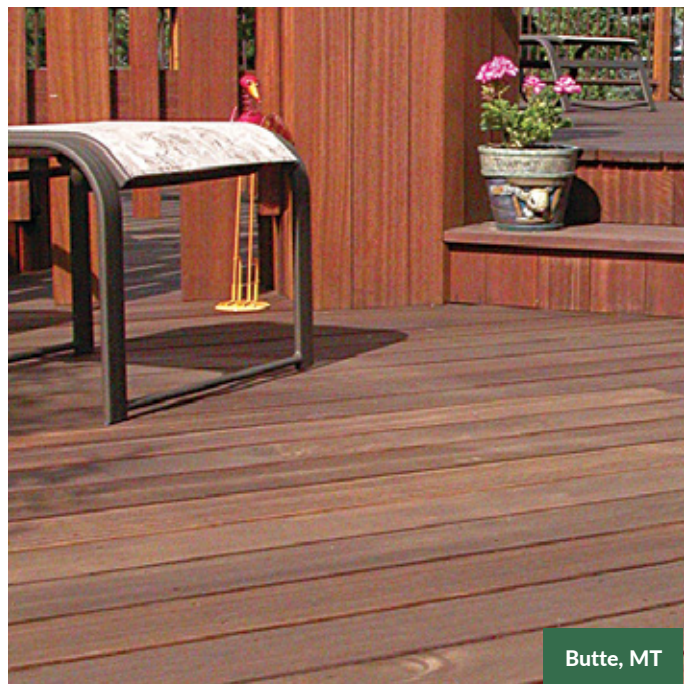

Butte, MT



# RUSTICSERIES™

By Woodtone



The natural *warmth & beauty of wood*

on durable fiber cement and engineered wood products. Eighteen beautiful, two-tone color combinations available, featuring a 20 year coating warranty.



**WOODTONE™**

always there, *naturally*

## Single-Family



Be involved in the design process, we'll help you create your forever home.

## Multi-Family

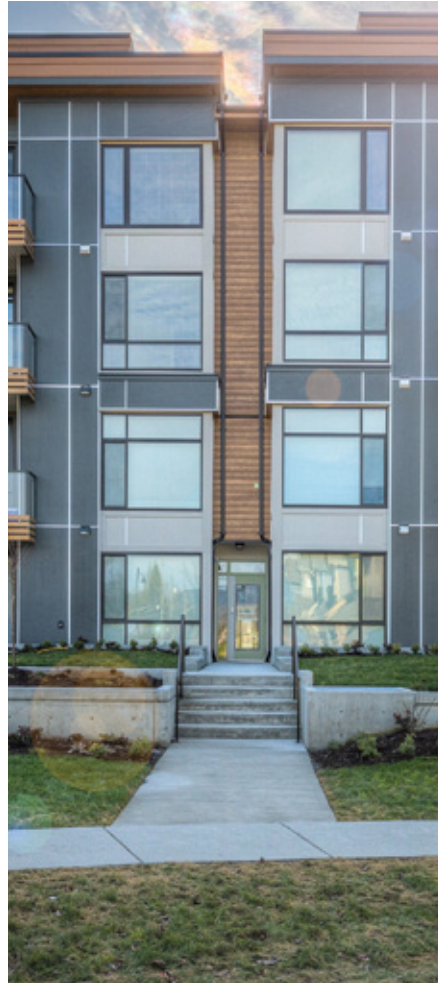

The number of multi-family developments is forever on the rise. Make your project stand out.

## Commercial



RusticSeries™ pairs well with many other products, combining to create a warm exterior.





Warm Espresso | Fiber Cement Lap Siding

Woodtone uses a variety of fiber cement and engineered wood profiles to create the perfect solution for your home.

**1. Select Material**

**2. Select Profile**

**3. Select Color**



**Material**

Fiber Cement  
Engineered Wood  
Select Wood Products



**Profile**

Lap Siding  
Shake Panels  
Panels, Trim



**Color**

18 Standard Colors  
Array of Styles  
Matching Trim Available

# INSTALLATION & FINISHING



## Finish Your Look With Trim



Outline your new siding with your choice of complementing trim products in RealTrim Plus™, fiber cement or engineered wood. Woodtone offers solid-body trim (pictured above), as well as matching two-tone trim.

## Beautiful Siding for Decades



RusticSeries™ coating is guaranteed for 20 years against failure. If you would like to enhance your home further after this period, RusticClarity can help restore your home to its original luster.

## Touch-Up Kits Make it Easy



Customized touch-up solutions are conveniently available for order. Exact color matching ensures consistency and provides a simple fix for dings or nicks.

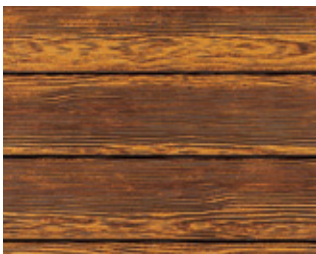

Lap Siding

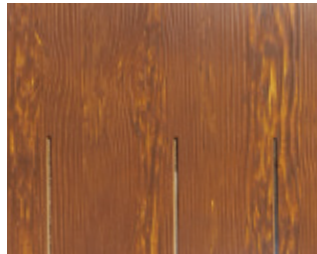

Shakes

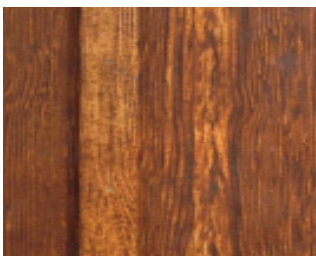

Panels



Matching Trim

## Complete Product Offering



Woodtone has teamed up with OSI sealants to provide a superior caulking solution. Each RusticSeries™ color has a corresponding OSI caulking color. When used together, there is a 20-year warranty on both products.

*NOTE: RusticSeries™ is known for replicating the natural beauty of wood siding. Just like wood siding, each substrate and each profile of this product varies in terms of grain pattern and color variance. The above are examples of RusticSeries™ coating on various substrates/profiles.*



# INSTALLATION & FINISHING



Select the Perfect Combination to Suit Your Individual Style. 18 Colors to Choose From.

COMPOSITE SIDING

Coastal Gray ●



Deception Gray  
OSI #501

River Rock ●



Stone Gray  
OSI #219

Summer Wheat ●



Whole Wheat Brown  
OSI #219

Warm Espresso ●

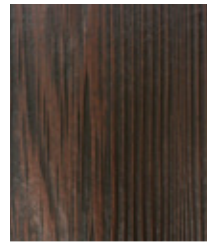

Chocolate  
OSI #236

Smoky Alder ●

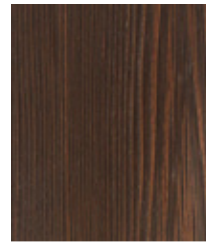

Trails End  
OSI #252

White Granite ○

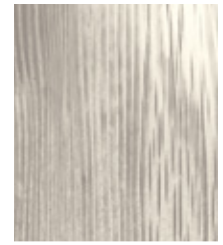

Cinder  
OSI #706

Aspen Ridge ○

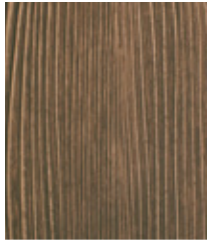

Chocolate Aspen  
OSI #221

Mountain Cedar ○



Mountain Bark  
OSI #223

Old Cherry ○

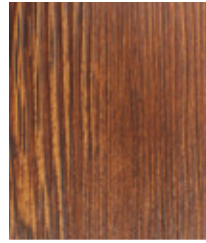

Cordovan Brown  
OSI #224

Rosewood ○



Sienna  
OSI #947

Timber Trail ○

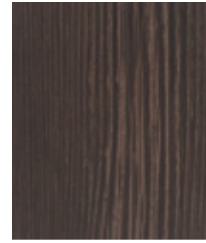

Bark  
OSI #287

Roasted Walnut ○



Bark  
OSI #201

Stone Blue ○



Slate Tile  
OSI #801

Tamarack Green ○



Black Fox  
OSI #263

Wild Berry ○

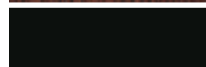
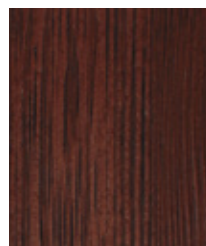

Black  
OSI #205

Vintage Cabernet ○

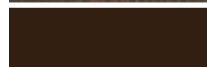
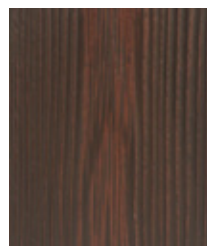

Cordovan Brown  
OSI #220

Winchester Brown ○

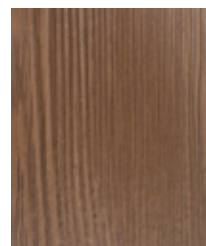

Bark Mulch  
OSI #211

Cascade Slate ○



Pewter  
OSI #565

\* Coastal Gray, River Rock, Summer Wheat, Smoky Alder, and Warm Espresso are stocked locally in Bozeman.

All other color options are available. Please check with your sales representative for lead times.

NOTE: Due to limitations of the printing process, actual color may vary from the color shown. Refer to a sample for accurate color.

# INSTALLATION & FINISHING



Select the Perfect Combination to Suit Your Individual Style. 18 Colors to Choose From.



Warm Espresso | Fiber Cement Lap Siding



Summer Wheat | Fiber Cement Lap Siding



Old Cherry | Fiber Cement Lap Siding



Summer Wheat | Engineered Wood Shakes



Aspen Ridge | Fiber Cement Lap Siding

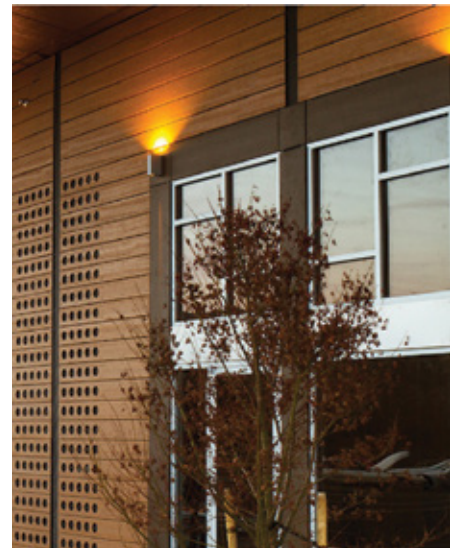

Mountain Cedar | Engineered Wood Lap Siding

COMPOSITE SIDING

# DUPONT™ TYVEK® DRAINWRAP™

## A Moisture Barrier Engineered For Enhanced Drainage

DuPont™ Tyvek® DrainWrap™ is an innovative weather resistive barrier engineered with a vertically-grooved surface. When combined with flashing and weeps, DuPont™ Tyvek® DrainWrap™ can promote bulk water drainage in wall systems by helping channel moisture safely to the outside.

- Improves drainage
- Is durable and maintains a constant drainage rate even after repeated wetting and drying cycles
- Offers excellent protection against water intrusion
- Helps reduce air infiltration to increase comfort
- Helps protect installed R-value of insulation

DuPont™ Tyvek® DrainWrap™ has been engineered to enhance the moisture management capability of wall systems by adding a drainage component to the traditional features of DuPont™ Tyvek® weather resistive barrier. This drainage attribute can help enhance the performance of a wall system by limiting the potential for wetting of components, in particular during heavy inclement conditions or in areas with substantial exposure to wind driven rain. DuPont™ Tyvek® DrainWrap™ will help enhance drainage behind claddings such as:

- Primed wood
- Fiber cement siding
- Foam board when applied over flat substrates

The unique, non-woven-fiber structure of DuPont™ Tyvek® DrainWrap™ is designed to manage water and moisture effectively. It helps resist air infiltration and water intrusion, yet is engineered to readily allow moisture vapor to diffuse through the sheet, helping reduce the chance of mold buildup and wood rot.



The drainage component of DuPont™ Tyvek® DrainWrap™ helps keep out bulk moisture and air, protects insulation, and reduces the chances of the formation of unhealthy mold.

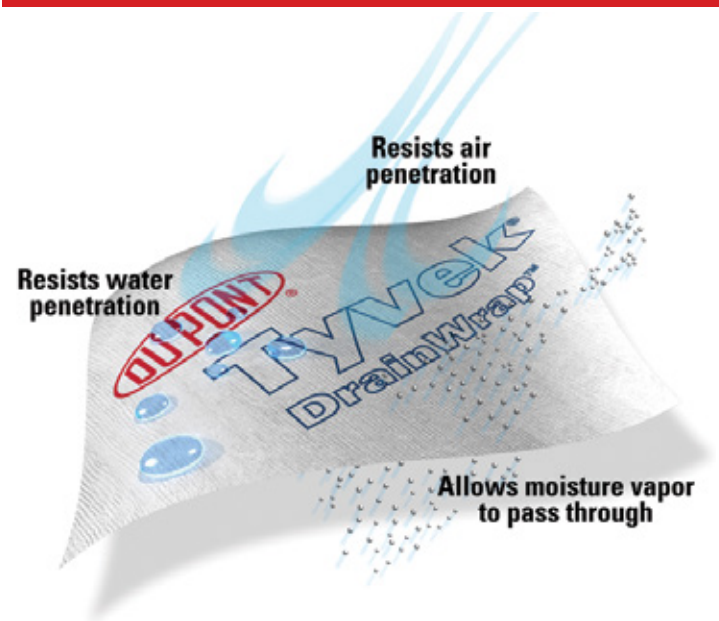



## A Moisture Barrier Engineered For Enhanced Drainage

DuPont™ Tyvek® DrainWrap™ improves drainage over other textured resistive barriers. To demonstrate typical drainage rates relative to DuPont™ Tyvek® DrainWrap™, bulk water was applied between a flat acrylic panel and the weather resistive barrier. The results are shown in Figure 1 below.

Grade D building paper wrinkles as it absorbs water and experiences wetting and drying cycles, which can create dams that hinder water drainage. This effect is illustrated in Figure 2 below, which shows a constant drainage rate for DuPont™ Tyvek® DrainWrap™ compared to a decreasing drainage rate for building paper after numerous cycles. The test was performed by introducing bulk water between a flat acrylic panel and the weather resistive barrier and measuring the drainage rate after numerous wetting and drying cycles.

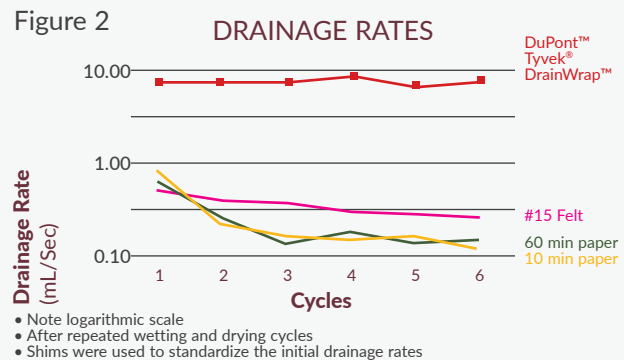
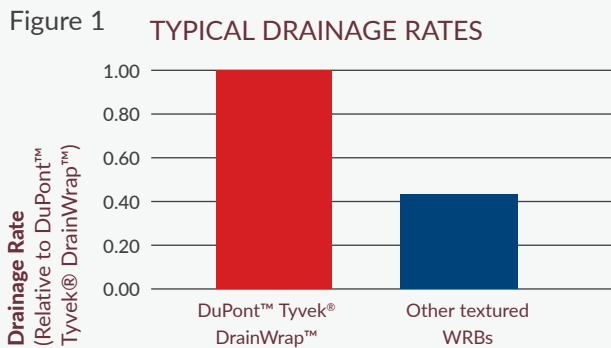

DuPont™ Tyvek® Building Science Bulletin (2005). DuPont™ Tyvek® DrainWrap™. Available from <http://digitalassets.dupont.com/>

### Installation Is Easier

DuPont™ Tyvek® DrainWrap™ is easy to install. It is pliable, so it wraps around corners with ease. Light weight, easier to handle, and faster to install. In addition, because it's flexible, DuPont™ Tyvek® DrainWrap™ easily interfaces at joints and over architectural elements. DuPont™ Tyvek® DrainWrap™ is available in 9 and 10 foot width rolls for use behind a variety of claddings. This wide roll minimizes seams and offers the potential for reduction in labor costs compared to narrower rolls.

### Support Throughout The Building Process

In addition to its superior performance, Tyvek® DrainWrap™ is backed by the quality, integrity and resources of DuPont™, the company that invented building wrap, including: the DuPont™ Certified Installer Program, offering training and certification for installation contractors; 10-year limited warranty from DuPont™; support from the DuPont™ Tyvek® Specialist Network. From the latest updates on building codes to on-site consulting and training, a local DuPont™ Tyvek® Specialist can help make sure the job gets done right.



# LINEAR FOOT & BOARD FOOTAGE FACTORS

## Dimensional Lumber | Board Foot Factors

Size	Factor	Size	Factor	Size	Factor	Size	Factor
1" x 2"	.1667	6/4" x 12"	1.5000	4" x 7"	2.3330	6" x 16"	8.0000
1" x 3"	.2500	2" x 2"	.3330	4" x 8"	2.6670	6" x 18"	9.0000
1" x 4"	.3330	2" x 3"	.5000	4" x 9"	3.0000	8" x 8"	5.3330
1" x 5"	.4167	2" x 4"	.6670	4" x 10"	3.3330	8" x 10"	6.6670
1" x 6"	.5000	2" x 5"	.83330	4" x 11"	3.6670	8" x 12"	8.0000
1" x 8"	.6667	2" x 6"	1.0000	4" x 12"	4.0000	8" x 14"	9.3330
1" x 10"	.8333	2" x 8"	1.3330	4" x 14"	4.6670	8" x 16"	10.667
1" x 12"	1.0000	2" x 10"	1.6670	4" x 16"	5.3330	8" x 18"	12.000
1" x 14"	1.1667	2" x 11"	1.8830	4" x 18"	6.0000	8" x 20"	13.333
1" x 16"	1.3333	2" x 12"	3.3330	4" x 20"	6.6660	8" x 22"	14.667
1" x 24"	2.0000	3" x 3"	.7500	4" x 22"	7.3330	8" x 24"	16.000
5/4" x 2"	.2083	3" x 4"	1.0000	4" x 24"	8.0000	10" x 10"	8.3330
5/4" x 3"	.3125	3" x 5"	1.2500	5" x 5"	2.0833	10" x 12"	10.0000
5/4" x 4"	.4167	3" x 6"	1.5000	5" x 6"	2.5000	10" x 14"	11.6670
5/4" x 5"	.5208	3" x 7"	1.7500	5" x 7"	2.9160	10" x 16"	13.3330
5/4" x 6"	.6250	3" x 8"	2.0000	5" x 8"	3.3330	10" x 18"	15.0000
5/4" x 8"	.8333	3" x 9"	2.2500	5" x 10"	4.1666	12" x 12"	12.0000
5/4" x 10"	1.0420	3" x 10"	2.5000	5" x 12"	5.0000	12" x 14"	14.0000
5/4" x 12"	1.2500	3" x 11"	2.7500	5" x 14"	5.8330	12" x 16"	16.0000
6/4" x 2"	.2500	3" x 12"	3.0000	5" x 16"	6.6660	12" x 18"	18.0000
6/4" x 3"	.3750	3" x 13"	3.2500	6" x 6"	3.0000	12" x 20"	20.0000
6/4" x 4"	.5000	3" x 14"	3.5000	6" x 8"	4.0000	12" x 22"	22.0000
6/4" x 5"	.6250	3" x 16"	4.0000	6" x 9"	4.5000	12" x 24"	24.0000
6/4" x 6"	.7500	4" x 4"	1.3330	6" x 10"	5.0000		
6/4" x 8"	1.0000	4" x 5"	1.6660	6" x 12"	6.0000		
6/4" x 10"	1.2500	4" x 6"	2.0000	6" x 14"	7.0000		

## Bevel Siding | Board Foot Factors

Description	Factor	Description	Factor	Description	Factor
1/2" x 4"	1.60	5/8" x 8"	1.24	3/4" x 6" Rabbeted	1.17
1/2" x 6"	1.34	3/4" x 8"	1.24	3/4" x 8" Rabbeted	1.13
3/4" x 6"	1.34	5/8" x 10"	1.18	1-1/4" x 6" Rabbeted	1.30
1/2" x 8"	1.24	3/4" x 10"	1.18	1-1/4" x 8" Rabbeted	1.25

# LINEAR FOOT & BOARD FOOTAGE FACTORS

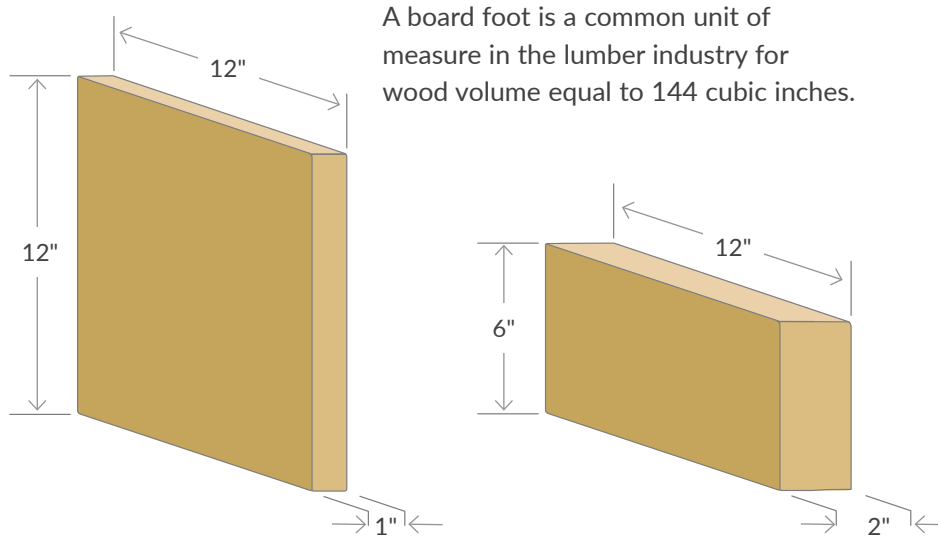

## WCLIB | Board Foot Factors

Description	Factor
5/8" x 4" Comb. Ceiling	1.28
1" x 4" Flooring	1.28
1" x 6" WC 105	1.20
1" x 8" WC 105	1.19

Description	Factor
1" x 6" WC 115	1.20
1" x 6" WC 117	1.20
1" x 4" WC 134	1.33
1" x 6" WC 134	1.20

Description	Factor
1" x 8" WC 134	1.19
1" x 4" WC 136	1.33
1" x 6" WC 136	1.20

### Log Cabin Siding Board Foot Factors

Size	Factor
2" x 6"	2.40
2" x 8"	2.28
2" x 10"	2.35
3" x 10"	3.43

### Channel Siding Board Foot Factors

Size	Factor
1" x 6"	1.24
1" x 8"	1.21
1" x 10"	1.16

### T&G Decking Board Foot Factors

Size	Factor
2" x 6"	2.40
2" x 8"	2.28
2" x 10"	2.35
3" x 10"	3.43

### WPA Patterns Board Foot Factors

Description	Factor
1" x 4" WP4	1.33
1" x 6" WP4	1.20
1" x 8" WP4	1.19
1" x 6" WP6	1.20

#### How to Use These Tables

To calculate board footage needed; multiply linear feet (LF) by conversion factor (CF). Example: 15 LF x 2.0 CF = 30 BF

# LUMBER & PLYWOOD WEIGHTS

Species	Description	Moisture	Weight
Douglas Fir	2" x 3" - 2" x 12" S4S	Green	2500 MBF
Douglas Fir	3" x 4" - 3" x 12" S4S	Green	2600 MBF
Douglas Fir	4" x 4" - 4" x 12" S4S	Green	2700 MBF
Douglas Fir	3" x 14" - 4" x 16" S4S	Green	2800 MBF
Douglas Fir	Rough Timbers	Green	3100 MBF
Douglas Fir	1" x 2" - 1" x 12"	Dried	2000 MBF
Douglas Fir	2" x 2" - 2" x 12"	Dried	2000 MBF
Douglas Fir	1" x 4" T&G Flooring	Dried	1800 MBF
Hemlock & Hem/Fir	2" x 4" - 2" x 12"	Kiln-Dried	1800# MBF
Hemlock & Hem/Fir	1" x 2" - 1" x 12"	Kiln-Dried	1700# MBF
Hemlock & Hem/Fir	1" x 4"; 1" x 6"; 1" x 8" WP4	Kiln-Dried	1500# MBF
Hemlock & Hem/Fir	5/8" x 4" T&G	Kiln-Dried	1200# MBF
Hemlock & Hem/Fir	2 x 6" T&G WC200	Kiln-Dried	1750# MBF
Pine	1" x 4" - 1 x 12 S4S	Kiln-Dried	1750# MBF
Pine	5/4" S4S	Kiln-Dried	2150# MBF
Pine	6/4" S4S	Kiln-Dried	2200# MBF
Pine	8/4" S4S	Kiln-Dried	2200# MBF
Pine	1" x 6"; 1" x 8" T&G	Kiln-Dried	1500# MBF
Redwood	2" x 4" - 2" x 12" S4S	Green	2700 MBF
Redwood	4" x 4" - 4" x 6" S4S	Green	3000 MBF
Redwood	6" x 6" S4S	Green	3000 MBF
Redwood	Rough Timbers	Green	500 MBF
Redwood	2" x 2" - 2" x 12" S4S	Dried	1600 MBF
Redwood	1" x 2" - 1" x 12" S4S	Dried	1500 MBF
Redwood	4" x 4" S4S	Dried	2000 MBF
Redwood	1/2" x 4" - 1/2" x 8" Bevel Siding		650 MBF
Redwood	5/8" x 6" - 5/8" x 10" Bevel Siding		750 MBF
Redwood	3/4" x 6" - 3/4" x 10" Bevel Siding		950 MBF
Redwood	1/2" x 4" - 1/2" x 6" T&G Pattern		950 MBF
Redwood	1" x 4", 1" x 6", 1" x 8" T&G Pattern		1500 MBF
Port Orford Cedar	5/4" S4S		1850 MBF
Port Orford Cedar	2" x 2" - 2" x 12"		1850 MBF
Port Orford Cedar	4" x 4"		2000 MBF
Western Red Cedar	2" x 2" - 2" x 12" S4S	Green	2500 MBF
Western Red Cedar	1" x 2" - 1" x 12" S4S	Green	2300 MBF
Western Red Cedar	5/4" x 4" - 5/4" x 12" S4S	Green	3000 MBF
Western Red Cedar	2" x 6" & Wider Full Sawn	Green	3000 MBF
Western Red Cedar	4" x 6" & Wider Full Sawn	Green	3100 MBF
Western Red Cedar	1" x 6"	Green	2000 MBF

# LUMBER & PLYWOOD WEIGHTS

Species	Description	Moisture	Weight
Western Red Cedar	1" x 8"	Green	2000 MBF
Western Red Cedar	1" x 10" Channel	Green	2000 MBF
Western Red Cedar	2" x 2" - 2" x 12" S4S	Kiln-Dried	1700 MBF
Western Red Cedar	1" x 2" - 1" x 12" S4S	Kiln-Dried	1650 MBF
Western Red Cedar	1/2" x 4" & 1/2" x 6" T&G	Kiln-Dried	900 MBF
Western Red Cedar	1" x 4" & 1" x 6" Bevel	Kiln-Dried	1550 MBF
Western Red Cedar	1/2" x 4" Bevel	Kiln-Dried	600 MBF
Western Red Cedar	1/2" x 6" Bevel	Kiln-Dried	600 MBF
Western Red Cedar	1/2" x 8" Bevel	Kiln-Dried	600 MBF
Western Red Cedar	3/4" x 8"; 3/4" x 10" Bevel	Kiln-Dried	900 MBF
Treated Lumber	2" x 2" - 2" x 12"	-	2550 MSF
Treated Lumber	3" x 6"	-	3050 MSF
Treated Lumber	4" x 4" - 4" x 12"	-	3050 MSF
Treated Lumber	4" x 6", 4" x 8", 8" x 8", Rough	-	3050 MSF
Treated Lumber	6" x 6" S4S	-	3500 MSF
Plywood	1/4" Sanded	-	725 MSF
Plywood	3/8" Sanded	-	1000 MSF
Plywood	1/2" Sanded	-	1300 MSF
Plywood	5/8" Sanded	-	1600 MSF
Plywood	3/4" Sanded	-	2000 MSF
Plywood	1" Sanded	-	2500 MSF
Plywood	1-1/8" Sanded	-	2950 MSF
Particle Board	3/8"	-	1400 MSF
Particle Board	1/2"	-	1800 MSF
Particle Board	5/8"	-	2250 MSF
Particle Board	3/4"	-	2850 MSF
Fire Retardant Lumber & Plywood	2" x 2" - 2" x 12"	-	1900 MSF
Fire Retardant Lumber & Plywood	1/2" CDX	-	1420 MSF
Fire Retardant Lumber & Plywood	5/8" CDX	-	1800 MSF
Fire Retardant Lumber & Plywood	3/4" CDX	-	2150 MSF
Split Rail Fencing	8' & 10' Rail & Posts	-	20 LB Ea

## How to Use These Tables

To calculate weight; multiply board footage (BF) by weight factor (WF). Example: 10 BF x 600 WF = 6000 lbs. *\*All lumber weights listed are approximate weights and may vary. This list is a helpful tool and not a guarantee of actual shipping weights.*



# SURFACING

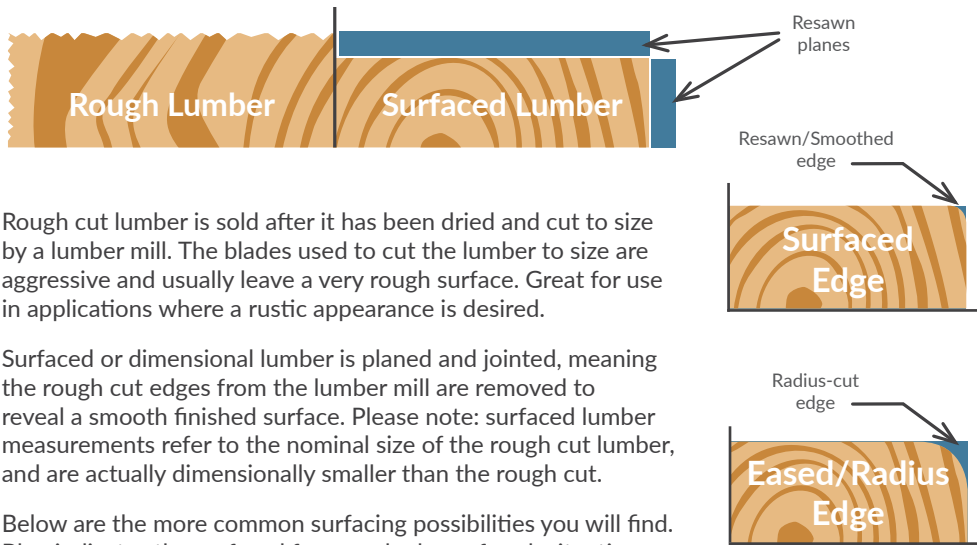

Rough cut lumber is sold after it has been dried and cut to size by a lumber mill. The blades used to cut the lumber to size are aggressive and usually leave a very rough surface. Great for use in applications where a rustic appearance is desired.

Surfaced or dimensional lumber is planed and jointed, meaning the rough cut edges from the lumber mill are removed to reveal a smooth finished surface. Please note: surfaced lumber measurements refer to the nominal size of the rough cut lumber, and are actually dimensionally smaller than the rough cut.

Below are the more common surfacing possibilities you will find. Blue indicates the surfaced faces and edges of each situation.

Surfaced edge is a finished edge surface devoid of rough edges, splinters, and a true corner.

Eased Edge, or Radius Edge is an edge that has been surfaced to form a rounded corner.

## COMMON SURFACING STYLES

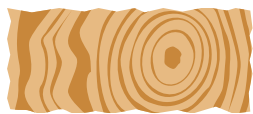

**Rough**  
Unsurfaced,  
rough cut lumber

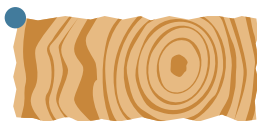

**S1E**  
Surfaced 1 Edge

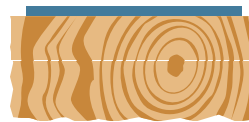

**S1S**  
Surfaced 1 Side

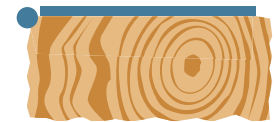

**S1S1E (uncommon)**  
Surfaced 1 Side  
Surfaced 1 Edge



**S1S2E**  
Surfaced 1 Side  
Surfaced 2 Edges



**S2E**  
Surfaced 2 Edges



**S2S**  
Surfaced 2 Sides



**S2S1E**  
Surfaced 2 Sides  
Surfaced 1 Edge

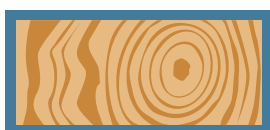

**S4S**  
Surfaced 4 Sides  
Surfaced 4 Edges

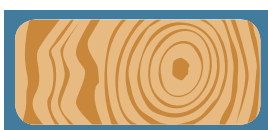

**S4SEE**  
Surfaced 4 Sides  
Eased All Edges (Radius Edges)

# TERMS

Term	Attribute Reference	Definition
2/BTR	Grading	Grade 2 and Better
A	Grading	Clear with no knots
A/BTR	Grading	Grade A and Better
B	Grading	Few minor defects (often combined with grade A and sold as B & better)
BTR	Grading	Used in grading rules to indicating the wood selected is at grade and better
C	Grading	Some small tight knots
C/BTR	Grading	GRADE C and Better
Clear All Heart	Grading	No defects and all heartwood on the graded side
CLR	Grading	Clear - meaning the board has no large defects and no knots on at least one edge and one side
Construction Common	Grading	Knots and sapwood allowed
Construction Heart	Grading	Heartwood with larger knots allowed
D	Grading	A few knots and defects
Deck Heart	Grading	Similar to construction heart but graded for strength
FAS	Grading	Firsts & Seconds - indicating a 1st and 2nd grade of quality
FOK	Grading	Free of Knots
Grade	Grading	Lumber is graded based on the amount of knots and defects
Heart B	Grading	Heartwood with a few knots allowed
MG	Grading	Mixed Grain - Pattern is a combination of flat and vertical graining
SEL	Grading	Select grade (best boards are pulled out from the total production)
Select	Grading	Similar to FAS but allows boards as narrow as 4" x 6'
STD/STD&BTR	Grading	Standard and Better
STK	Grading	Select Tight Knot
TK	Grading	Tight Knot
VG	Grading	Vertical Grain - graining contained in a board runs straight up and down the board, parallel to the length
CLF	Measuring	Hundred Linear Feet - measurement common with molding
FB or F	Measuring	A term used to determine strength - fiber stress in bending
LGR	Measuring	Longer
LIN also LF	Measuring	Linear Foot
MBF	Measuring	Thousand board feet
RW/L	Measuring	Random Widths and Lengths - common with hardwood, bundles containing assorted board widths and non-standard sizes
SF	Measuring	Square Feet
GRN	Moisture	Green, undried logs cut into boards or timbers
HT	Moisture	Heat treated to kill insects and eggs, important in export lumber
KD	Moisture	Kiln-dried
KDAT	Moisture	Kiln-dried after treatment - products dried (again) after application of chemicals for rot or fire resistance
MC	Moisture	Moisture content - percentage of water in any given piece of wood
PAD	Moisture	Partly Air Dried - moisture content indeterminate

# TERMS

Term	Attribute Reference	Definition
E&CB2S	Pattern	Edge & Center Bead 2-Sides Pattern on paneling
E&CV1S	Pattern	Edge & Center V, 1-Side on siding/paneling
E&CV2S	Pattern	Edge & Center V, 2-Sides on siding/paneling
EB1S	Pattern	Edge Bead, 1 Side
EB2S	Pattern	Edge Bead, 2 Sides
Rabbeted	Pattern	Slot or dado on the lower edge of siding
ShipLap	Pattern	Pattern on sidings where the rabbeted edge of one board overlays the machined edge of the next
T&G	Pattern	Tongue and Groove
E	Species	Edge
ES	Species	Englemann Spruce
ESLP	Species	Englemann Spruce, Lodgepole Pine
IC	Species	Incense Cedar species
LP	Species	Lodgepole Pine
Eased Edge	Surfacing	Eased or rounded Edges on a finished product
EE	Surfacing	Eased or rounded Edges on a finished product
EV1S	Surfacing	Edge V, 1 Side
EV2S	Surfacing	Edge V, 2 Sides
FSRGH	Surfacing	Full Sawn Rough
G1S	Surfacing	Good 1 Side (plywood)
G2S	Surfacing	Good 2 Sides (plywood, mdo, etc)
H&M also (H or M)	Surfacing	Hit or miss planing, not a finished surface
R/S	Surfacing	Resawn - a mill process to re-cut the wood to freshen the surface
Radius Edge	Surfacing	Eased or rounded Edges on a finished product
S1E	Surfacing	Surfaced 1 Edge
S1S	Surfacing	Surfaced 1 Side
S1S1E	Surfacing	Surfaced 1 side, 1 Edge (not common)
S1S2E	Surfacing	Surfaced 1 Side 2 Edges
S2E	Surfacing	Surfaced 2 Edges
S2S	Surfacing	Surfaced 2 Sides
S2S1E	Surfacing	Surfaced 2 Sides, 1 Edge (not common)
S4S	Surfacing	Surfaced 4 Sides
S4SEE	Surfacing	Surfaced 4 Sides Eased Edges
S-DRY	Surfacing	Surfaced Dry
V&CENTER	Surfacing	V-Joints on the 2 Edges of the smooth face, and Center V groove
V2E	Surfacing	V-Joints on 2 Edges of the smooth face
V4E	Surfacing	V-Joints on all 4 Edges

# RUSTICSERIES™

By Woodtone

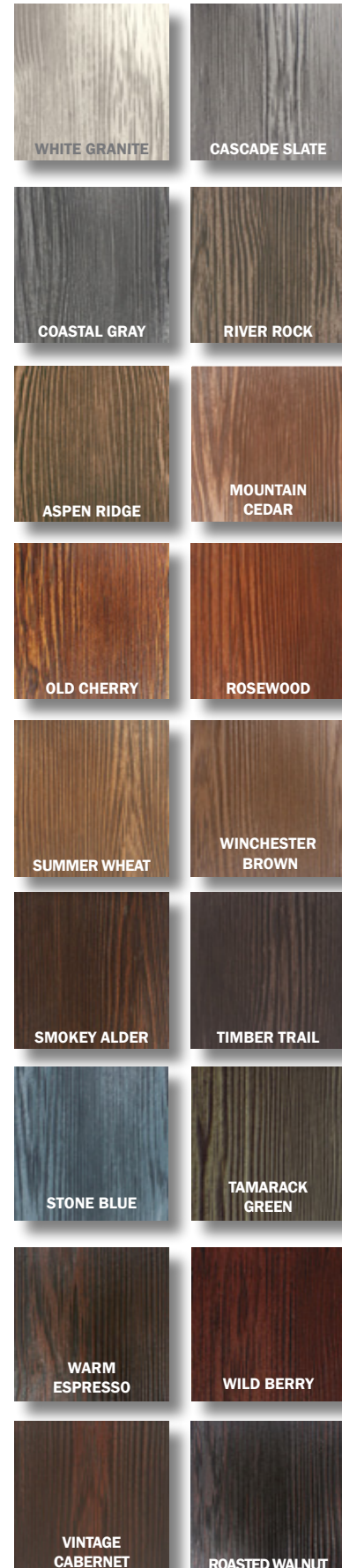

The natural *warmth & beauty of wood* on durable fiber cement and engineered wood products. 18 beautiful color combinations featuring a 15 year warranty.

## WOODTONE™

always there, *naturally*

The colors represented in this brochure may vary from actual product. Visit our website to order samples, visualize your forever home and find new inspiration.

800-663-9844  
woodtone.com





# PRODUCT GUIDE

TIMBERS | LUMBER | SIDING | MOULDING | DOORS | TRIM | AND MORE

